

ARK-3440 A2 1st Gen. Intel® Core™ i3/i5/i7 with PCI/PCIe Expansion Slots Fanless Box PC



Features

- Intel® Core™ i3/i5/i7 Fanless Embedded Box PC
- Multi-display and support for wide screen with high resolution
- Supports 2 GbE, eSATA, 6 USB 2.0, audio and 3 COM ports
- Two internal 2.5" SATA HDD bays
- Various expansion interfaces for diverse applications
- Easy integration, easy maintenance, and wide input voltage range 9 ~ 34 V
- IP40 sealed design



Specifications

Processor System	CPU	Intel Core i7 610E (Dual Core)	Intel Core i5 520E (Dual Core)	Intel Core i3 330E (Dual Core)
	Frequency	2.53 GHz	2.4 GHz	2.13 GHz
	L2 Cache	4MB	3MB	3MB
	System Chipset	Intel QM57		
	BIOS	AMI 16 Mbit SPI BIOS		
Memory	Technology	DDR3 1066 MHz		
	Max. Capacity	8 GB		
	Socket	2 x 204-pin SO-DIMM		
Graphics	Chipset	Integrated graphics built in Intel QM57		
	Interface	VGA: up to 2048 x 1536 (By DVI-I to VGA adaptor) DVI-D: up to 1920 x 1200 HDMI 1.3 up to 1920 x 1200 24-bit LVDS: up to 1920 x 1200 (Optional)		
Ethernet	LAN 1	10/100/1000 Mbps, Intel 82577LM, support Wake On LAN		
	LAN 2	10/100/1000 Mbps, Intel 82583V, support Wake On LAN		
Audio	Amplifier	-		
	Interface	Line-in, Line-out, Mic-in		
IO interface	Serial Interface	2 x RS232, 1 x RS232/422/485 (w/auto flow control)		
	USB Interface	6 x USB ports, compliant with USB 2.0		
	Parallel Port	Supports D-sub 25-pin connector (optional)		
	Digital I/O	-		
Expansion	PCI/PCIe Slot	1 Slot PCI and 1 Slot PCIe x1 (default); 2 Slots PCIe x1 (optional); 2 Slots PCI (optional) ; 1 Slot PCI and 1 Slot PCIe x4 (optional) Supports maximum dimension of 167 mm (width) x 106 mm (length) for expansion PC board		
	Mini PCIe	2 x Mini PCIe		
Storage	HDD	Supports 2 x SATA 2.5" HDD Bays (Max. Data Transfer Rate 300 MB/s) (Internal bay: up to 12.8mm height, Removable bay: up to 9.5mm height)		
	SSD	Supports CompactFlash socket for type I/II CompactFlash disk		
Software Support	Microsoft Windows	Windows 7, XP Professional, XP Embedded		
	Linux	Fedora 14		
Power Requirement	Power Type	AT/ATX		
	Power Input Voltage	9 V _{DC} ~ 34 V _{DC}		
	Minimum Power Input	DC 9-34V @ 6.0-1.5A		
	Power Adapter	AC to DC, DC19V/7.89A, 150W (Optional)		
Power Consumption	Typical	17.1 W		
	Max.	53 W		
Mechanical	Construction	Aluminum housing		
	Mounting	Desk/wall-mounting		
	Dimensions (W x H x D)	220 mm x 117 mm x 200 mm (8.66" x 4.61" x 7.87")		
	Weight	4 kg (8.8 lb)		
Environment	Operating Temperature	With extended temperature peripherals CompactFlash disk: 0 ~ 50° C, with 0.7m/sec air flow With extended temperature memory and consumer grade 2.5-inch hard disk on internal drive bay 0 ~ 45° C, with 0.7m/sec air flow		
	Storage Temperature	-40 ~ 85° C (-40~185°F)		
	Relative Humidity	95% @ 40° C (non-condensing)		
	Vibration Loading During Operation	With CompactFlash disk: 5 Grms, IEC 60068-2-64, random, 5 ~ 500 Hz, 1 Oct./min, 1 hr/axis. With 2.5-inch hard disk: 1 Grms, IEC 60068-2-64, random, 5 ~ 500 Hz, 1 Oct./min, 1 hr/axis.		
	Shock During Operation	With CompactFlash disk: 50 G, IEC 60068-2-27, half sine, 11 ms duration With hard disk: 20 G, IEC 60068-2-27, half sine, 11 ms duration		
	EMC	CE/FCC Class A, CCC, BSMI		
	Safety Certifications	UL, CCC, BSMI		

Dimensions

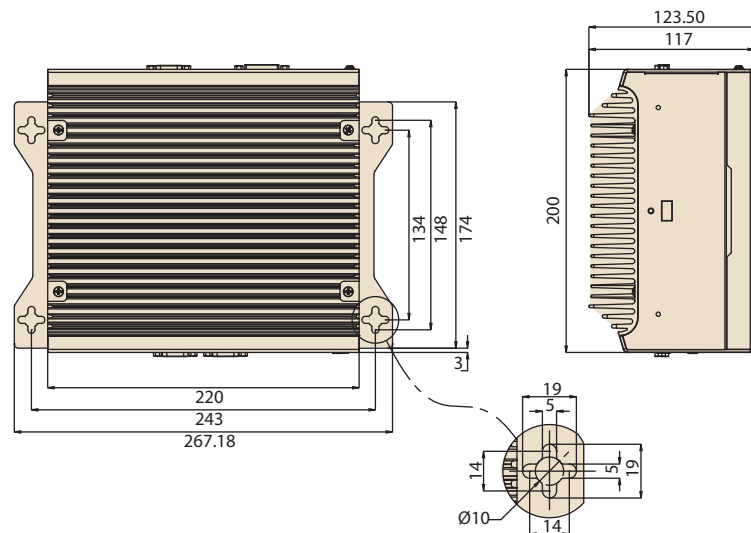

Front Panel External I/O Mechanical Layout/Drawing

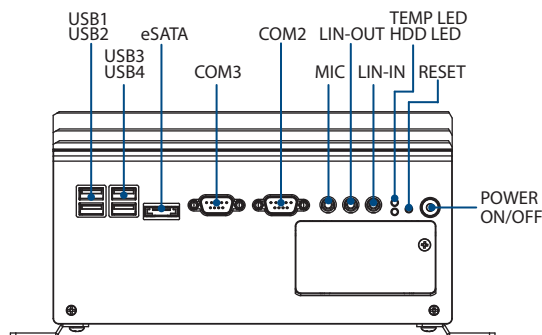

Rear Panel External I/O Mechanical Layout/Drawing

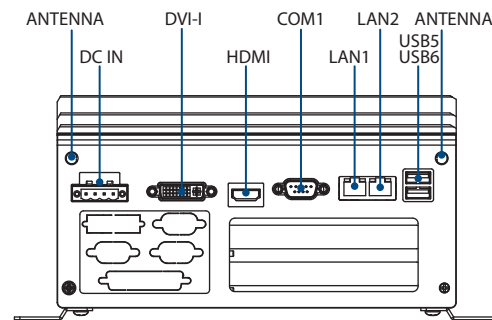

Ordering Information

Part No.	CPU	L2 Cache	HDMI	DVI-I	GbE	RS-232/422/485	RS-232	USB 2.0	MiniPCIe	DC input	Expansion
ARK-3440F-U5A2E	Intel Core i7 610E 2.53 GHz	4 MB									
ARK-3440F-U4A2E	Intel Core i5 520E 2.4 GHz	3 MB	Yes	Yes	2	1	2	6	2	9 ~ 34 V _{DC}	1 PCIe1 + 1 PCI
ARK-3440F-U1A2E	Intel Core i3 330E 2.13 GHz	3 MB									

Note: Memory, storage and operating system bundled by request.

Packing List

Part Number	Description
-	1 x ARK-3440 Unit
-	1 x Driver/Utility CD/Manual
1960014487T00C	2 x desk/wall mount plate
1652003234	1 x 4-pin Phoenix DC power connector
1654009744	1 x DVI-I to CRT connector
1990020592N001	1x HDD thermal pad
1990020828N001	1 x CPU thermal grease pad

Embedded OS

Part Number	Description
2070009811	WES2009 ARK-3440 ENG_FRE_GER_ITA_SPA
2070009812	WES2009 ARK-3440 ENG_CHT_CHS_JPN
2070011270	WES7E ARK-3440 ENG 32 bit

Optional Items

Part Number	Description
1757002161	AC-to-DC adapter, DC19 V/7.89A 150 W, with phoenix power plug, 0 ~ 40° C for home and office Use
1757004529-01	AC-to-DC Adapter, DC 19V/6.84A 130W, -20 ~ +70° C
1702002600	Power cable 3-pin 180cm, USA type, for 1757002161 and 1757004529-01
1700004713	CABLE DVI-I to DVI-D and CRT
1702002605	Power cable 3-pin 180cm, EU type, for 1757002161 and 1757004529-01
1702031801	Power cable 3-pin 180cm, UK type, for 1757002161 and 1757004529-01
1700018187	LPT cable 2 x 130-2.0/D-SUB 25P(F) 20 cm for ARK-3440
1700008871	COM Cable D-SUB 9P(M)/IDE#2 10P-2.0 20 cm
AMO-R010E	2 slot riser card, 1 x PCIe x1 + 1 x PCI
AMO-R009E	2 slot riser card, 2 x PCIe x1
AMO-R013E	2 slot riser card, 2 x PCI
AMO-R014E	2 slot riser card, 1 x PCI + 1 x PCIe x4 with BIOS V2.00 (P/N: 1420030396)