

CS-115/P2002 Series

15" TFT-LCD Sunlight Readable Touch Panel PC with 6th Gen. Intel® Core™ Processor



HIGH-PERFORMANCE SUNLIGHT READABLE PANEL PC

| CS-100/P2000 Series |

Overview

 CONTACT

CS-100/P2002 Series is a 12.1" - 24" TFT-LCD sunlight readable touch panel PC offering 1,500 nits ultra high brightness and 1024 x 768 - 1920 x 1080 (XGA) resolution. The system is equipped with high-performance Intel® 6th generation Core™ U series processor and provides extensive I/O including 2x GbE, 5x USB, 6x RS232/422/485, 8x DI/8x DO, 1x VGA and 1x DVI-D. It also supports 2x Mini-PCIe slot and 1x SIM socket for a variety of wireless connections, such as BT/WiFi and 3G/LTE. In addition, there are 3 types of storage devices including 2.5" SATA HDD (RAID 0/1), mSATA and CFAST. The accessible design of these storage devices allows quick data access and easy maintenance. CS-100/P2002 Series supports Convertible Display System (CDS) technology. Comparing to regular standalone panel PCs, it can lower maintenance cost and reduce unplanned downtime. For greater flexibility, CS-100/P2000 Series has PCI/PCIe expandable version and PoE/power ignition functions by additional CFM (Control Function Module). Furthermore, CS-100/P2002 Series is a truly rugged display system supporting wide range operating temperature, IP65 dust/waterproof front panel, wide range DC power input (9 to 48VDC) and rigorous industrial protections.

Key Features

- 15" TFT-LCD with Ultra High Brightness up to 1,800 nits and 1024 x 768 (XGA) Resolution
- Onboard Intel® 6th Generation Core™ Processor U Series (15W)
- Supports 2x DDR4 SO-DIMM Socket, up to 32 GB
- Integrated Intel® HD Graphics 520, Triple Display Support
- 2x 2.5" SATA Drive Bay, 1x mSATA, and 1x CFAST Socket
- Rich I/O (2x GbE LAN, 6x COM, 5x USB, 16x Isolated DIO)
- 2x Full-size Mini-PCIe Socket for Wireless and I/O Expansion
- Wide Range Operating Temperature
- Designed with Aluminum Die-casting Front Frame
- True Flat IP65 Front Panel Protection
- Supports Panel / VESA / Rack Mounting
- Convertible Display System (CDS) Technology Supported
- PCI/PCIe Expandable Version Available (For P2002E only)

Certifications



Sunlight Readable

Providing ultra high brightness 1,500 nits - 1,800 nits and resolution up to 800 x 600 - 1920 x 1080 (XGA), CS-100/P2000 Series is suitable for all lighting conditions including direct sunlight.



High Performance

Powered by Intel® 6th Gen. Core™ Processor U Series, CS-100/P2000 Series Panel PC has greatly increased computing performance and power efficiency.

Wide Temperature

CS-100/P2000 Series supports wide range operating temperature and is suitable for deploying in extreme and harsh environments.



CS-115 Specifications

Model Name	CS-115
Display	
LCD Size	• 15" (4:3)
Max. Resolution	• 1024 x 768 (XGA)
Brightness (cd/m2)	• 1800
Contrast Ratio	• 800 : 1
LCD Color	• 16.2M
Pixel Pitch (mm)	• 0.297 (H) x 0.297 (V)
Viewing Angle (H-V)	• 160 / 150
Backlight LED Life Time	• 50,000 hrs (LED Backlight)
Touch Screen	
Touch Type	• Projected Capacitive
Wet Touch Tracking	v
Physical	
Dimension (W x D x H)	• 408 x 312.4 x 59.2 mm
Weight Information	• 4.36kg
Mechanical Construction	• Flat Rugged Aluminum Die-casting Bezel
Power	
Power Consumption	• 27.26W (Max.)
Environment	
Front Panel Protection	• IP 65 Compliant
Operating Temperature	• -20°C to 70°C (-4°F to 158°F) (With Industrial Grade Peripherals; Ambient with air flow)
Storage Temperature	• -30°C to 70°C (-22°F to 158°F)
Relative Humidity	• 90% RH @ 40°C (Non-condensing)
EMC	• CE, UKCA, FCC, ICES-003 Class A
EMI	<ul style="list-style-type: none"> • CISPR 32 Conducted & Radiated: Class A • EN/BS EN 55032 Conducted & Radiated: Class A • EN/BS EN IEC 61000-3-2 Harmonic current emissions: Class A • EN/BS EN61000-3-3 Voltage fluctuations & flicker • FCC 47 CFR Part 15B, ICES-003 Conducted & Radiated: Class A
EMS	<ul style="list-style-type: none"> • EN/IEC 61000-4-2 ESD: Contact: 4 kV; Air: 8 kV • EN/IEC 61000-4-3 RS: 80 MHz to 1000 MHz: 3 V/m • EN/IEC 61000-4-4 EFT: AC Power: 1 kV; DC Power: 0.5 kV; Signal: 0.5 kV • EN/IEC 61000-4-5 Surges: AC Power: 2 kV; Signal: 1 kV • EN/IEC 61000-4-6 CS: 3V • EN/IEC 61000-4-8 PFMF: 50 Hz, 1A/m • EN/IEC 61000-4-11 Voltage Dips & Voltage Interruptions: 0.5 cycles at 50 Hz
Safety	• UL, cUL, CB, IEC, EN 62368-1

P2002 Series Specifications

Model Name	P2002	P2002E
System		
Processor	<ul style="list-style-type: none"> Onboard 6th Intel® Core™ U processors (Skylake) <ul style="list-style-type: none"> Intel® Core™ i5-6300U processor (3M Cache, up to 3.00 GHz) Intel® Core™ i3-6100U processor (3M Cache, 2.30 GHz) TDP: 15 W 	
Memory	<ul style="list-style-type: none"> 2x DDR4 2133 MHz 260-Pin SO-DIMM Socket Support Un-buffered and Non-ECC Type up to 32 GB 	
BIOS	<ul style="list-style-type: none"> AMI 64Mbit SPI BIOS 	
Graphics		
Graphics Engine	<ul style="list-style-type: none"> Integrated Intel® UHD Graphics 520 	
Maximum Display Output	<ul style="list-style-type: none"> Supports Triple Independent Display 	
CDS	<ul style="list-style-type: none"> 1x CDS Connector for Cincoze Display Module 	
VGA	<ul style="list-style-type: none"> 1x VGA Connector(1920 x 1080 @60Hz), DB-15 	
DVI-D	<ul style="list-style-type: none"> 1x DVI-D Connector (1920 x 1080 @ 60Hz) 	
Audio		
Audio Codec	<ul style="list-style-type: none"> Realtek® ALC888, High-Definition Audio 	
Speaker-out	<ul style="list-style-type: none"> 1x Speaker-out, Phone Jack 3.5mm 	
Mic-in	<ul style="list-style-type: none"> 1x Mic-in, Phone Jack 3.5mm 	
I/O		
LAN	<ul style="list-style-type: none"> 2x GbE LAN (Supports WoL, Teaming, Jumbo Frame & PXE), RJ45 <ul style="list-style-type: none"> GbE1: Intel® I219LM GbE2: Intel® I210 	
USB	<ul style="list-style-type: none"> 4x USB 3.2 Gen1 (Type A), 1x USB 2.0 (Type A) 	
Serial Port	<ul style="list-style-type: none"> 6x RS-232/422/485 with Auto Flow Control Support 5V/12V, DB9 	
DIO	<ul style="list-style-type: none"> 16x Isolated Digital I/O (8in/8out), 10-Pin Terminal Block 	
Storage		
SSD/HDD	<ul style="list-style-type: none"> 2x 2.5" HDD/SSD Bay, Support RAID 0/1 (Gen3) 	
mSATA	<ul style="list-style-type: none"> 2x mSATA (One Shared by Mini-PCIe Socket) (Gen2) 	
CFast	<ul style="list-style-type: none"> 1x CFast Socket (Gen 3) 	
Expansion		
Mini PCI Express	<ul style="list-style-type: none"> 2x Full-size Mini-PCIe Sockets 	
PCI Express	<ul style="list-style-type: none"> 1x PCI or 1x PCIe x4 Expansion slot (with Optional Riser Card) maximum dimension of add-on card:100mm x 200mm (H x L) 	
SIM Socket	<ul style="list-style-type: none"> 1 x Front Accessible SIM Socket 	
Universal Bracket	<ul style="list-style-type: none"> 1x Universal I/O Bracket 	
CFM (Control Function Module) Interface	<ul style="list-style-type: none"> 2x CFM Interface for optional CFM-IGN or CFM-PoE (max 25.5W) Module Expansion 	
CDS (Convertible Display System) Technology	<ul style="list-style-type: none"> 1x Convertible Display System (CDS) Interface, Compact PCI Connector 	

Other Function		
Instant Reboot	• Support 0.2sec Instant Reboot technology	
Watchdog Timer	• Software Programmable Supports 256 Levels System Reset	
Internal Speaker	• AMP 2W + 2W	
OSD Function	• LCD On/Off, Brightness Up, Brightness Down	
Reset Button	• 1x Reset Button	
External Fan Connector	• 1x External Fan Connector, 4-pin Terminal Block	
Power		
Power Button	• 1x ATX Power On/Off Switch	
Power Mode Switch	• 1x AT/ATX Mode Switch	
Power Input	• 1x 3-pin Terminal Block Connector with Power Input 9~48VDC	
Power Adapter (Optional)	• 1x Optional AC/DC 12V/5A 60W or 24V/5A 120W • 1x Optional AC/DC 24V/9.2A 220W (For P2002E only)	
Remote Power On/Off	• 1x Remote Power On/Off Connector, 2-pin Terminal Block	
Physical		
Dimension(W x D x H)	• 254.5 x 220 x 54mm	• 254.5 x 220 x 72 mm
Weight Information	• 2.92 kg	• 3.18 kg
Mechanical Construction	• Extruded Aluminum with Heavy Duty Metal	
Mounting	• Wall / VESA / CDS	
Physical Design	• Fanless Design • Jumper-less Design	
Reliability & Protection		
Reverse Power Input	• Yes	
Over Voltage Protection	• Protection Range: 51~58V • Protection Type: shut down operating voltage, re-power on at the present level to recover	
Over Current Protection	• 15A	
CMOS Battery Backup	• SuperCap Integrated for CMOS Battery Maintenance-free Operation	
Operating System		
Microsoft® Windows®	• Windows® 10, Windows® 8.1, Windows® 7	
Linux	• Linux® Kernel 4.4	
Environment		
Operating Temperature	• Ambient with Air Flow: -25°C to 70°C (with Extended Temperature Peripherals)	
Storage Temperature	• -40°C to 85C	
Relative humidity	• 95% RH @ 40°C (Non-condensing)	
Shock	• Operating, 50 Grms, Half-sine 11ms Duration (w/ SSD, according to IEC60068-2-27)	
Vibration	• Operating, 5 Grms, 5-500 Hz, 3 Axes (w/ SSD, according to IEC60068-2-64)	
EMC	• CE, UKCA, FCC, ICES-003 Class A	

EMI	<ul style="list-style-type: none"> • CISPR 32 Conducted & Radiated: Class A • EN/BS EN 55032 Conducted & Radiated: Class A • EN/BS EN IEC 61000-3-2 Harmonic current emissions: Class A • EN/BS EN61000-3-3 Voltage fluctuations & flicker • FCC 47 CFR Part 15B, ICES-003 Conducted & Radiated: Class A
EMS	<ul style="list-style-type: none"> • EN/IEC 61000-4-2 ESD: Contact: 4 kV; Air: 8 kV • EN/IEC 61000-4-3 RS: 80 MHz to 1000 MHz: 3 V/m • EN/IEC 61000-4-4 EFT: AC Power: 1 kV; DC Power: 0.5 kV; Signal: 0.5 kV • EN/IEC 61000-4-5 Surges: AC Power: 2 kV; Signal: 1 kV • EN/IEC 61000-4-6 CS: 3V • EN/IEC 61000-4-8 PFMF: 50 Hz, 1A/m • EN/IEC 61000-4-11 Voltage Dips & Voltage Interruptions: 0.5 cycles at 50 Hz

CS-115/P2002 External Layout

Front I/O

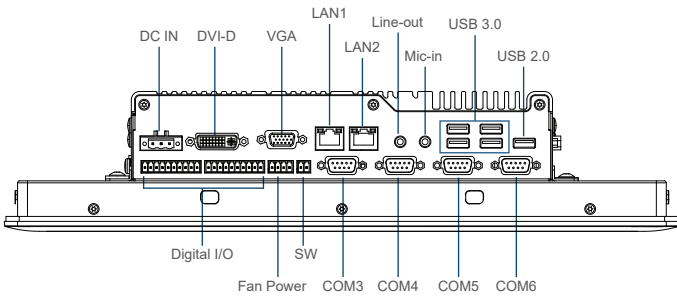

Rear I/O

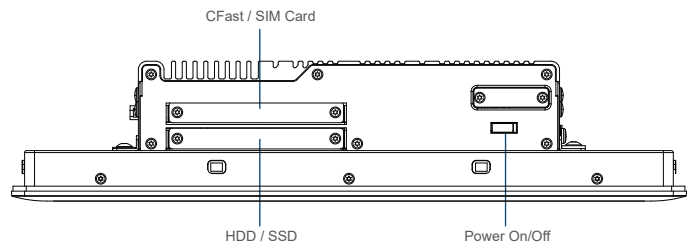

Left I/O

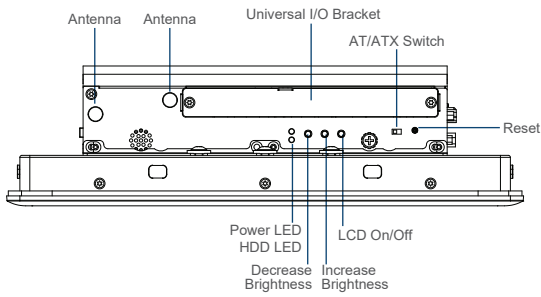

Right I/O

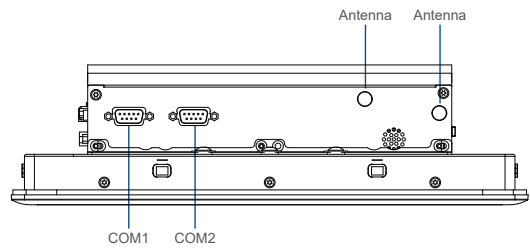

CS-115/P2002E External Layout

Front I/O

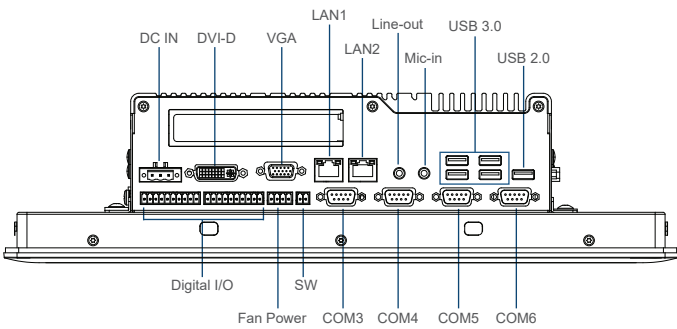

Rear I/O

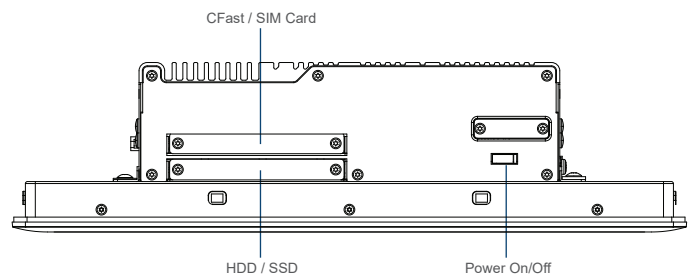

Left I/O

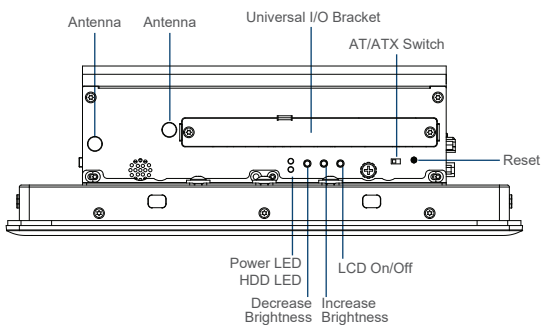

Right I/O

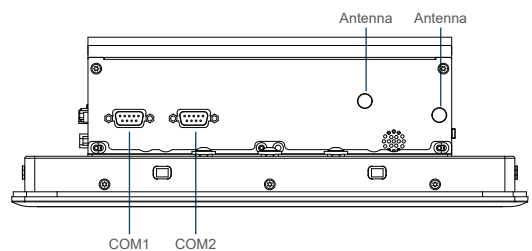

CS-115/P2002 Dimensions

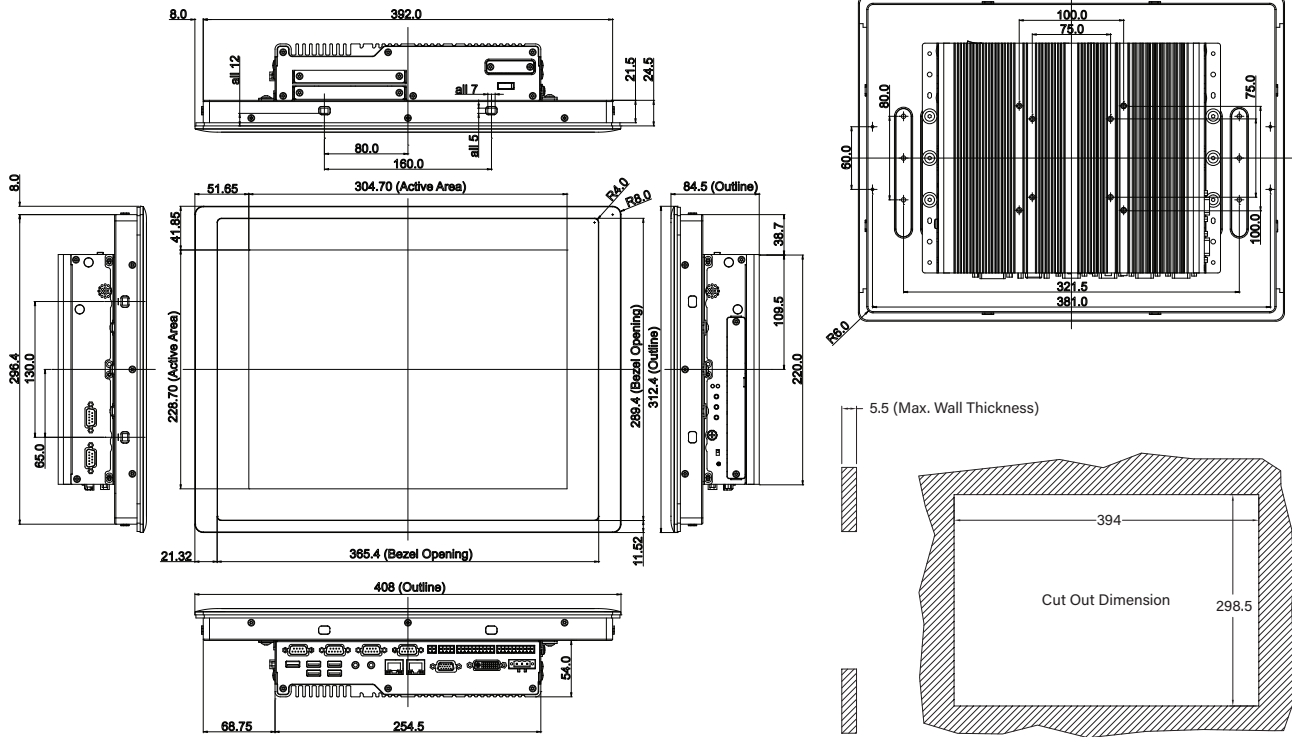

CS-115/P2002E Dimensions

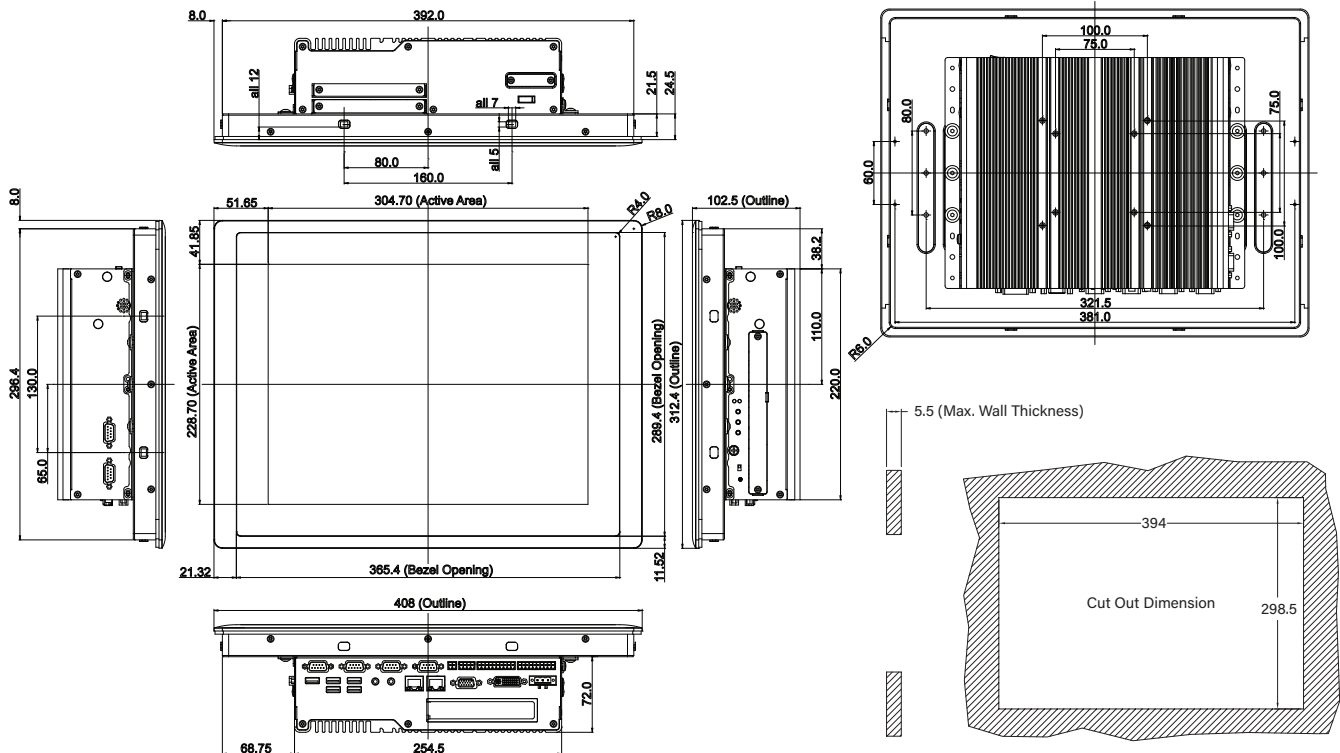

Ordering Information

Available Models

Model No.	Description
CS-115C-R10/P2002-i5-R10	15" TFT-LCD 1800 nits Sunlight Readable Touch Panel PC with Intel® Core™ i5-6300U Processor and P-Cap. Touch
CS-115C-R10/P2002E-i5-R10	15" TFT-LCD 1800 nits Sunlight Readable Touch Panel PC with Intel® Core™ i5-6300U Processor, P-Cap. Touch and 1x Reserved Expansion Slot
CS-115C-R10/P2002E-i5-E4-R10	15" TFT-LCD 1800 nits Sunlight Readable Touch Panel PC with Intel® Core™ i5-6300U Processor, P-Cap. Touch and 1x PCIe x4 Expansion Slot
CS-115C-R10/P2002E-i5-PI-R10	15" TFT-LCD 1800 nits Sunlight Readable Touch Panel PC with Intel® Core™ i5-6300U Processor, P-Cap. Touch and 1x PCI Expansion Slot
CS-115C-R10/P2002-i3-R10	15" TFT-LCD 1800 nits Sunlight Readable Touch Panel PC with Intel® Core™ i3-6100U Processor and P-Cap. Touch
CS-115C-R10/P2002E-i3-R10	15" TFT-LCD 1800 nits Sunlight Readable Touch Panel PC with Intel® Core™ i3-6100U Processor, P-Cap. Touch and 1x Reserved Expansion Slot
CS-115C-R10/P2002E-i3-E4-R10	15" TFT-LCD 1800 nits Sunlight Readable Touch Panel PC with Intel® Core™ i3-6100U Processor, P-Cap. Touch and 1x PCIe x4 Expansion Slot
CS-115C-R10/P2002E-i3-PI-R10	15" TFT-LCD 1800 nits Sunlight Readable Touch Panel PC with Intel® Core™ i3-6100U Processor, P-Cap. Touch and 1x PCI Expansion Slot

Model Configuration

	CS-115C	P2002(i3/i5)	P2002E(i3/i5/E4/PI)
CS-115C/P2002	V	V	--
CS-115C/P2002E	V	--	V

V : Compatible

Package Checklist

• CS-115/P2002 Series Panel PC x 1	• Power Terminal Block Connector (Female) x 1
• Panel Mounting Kit x 1	• Screw Pack x 1
• Fan Terminal Block Connector x 1	• Remote Power On/Off Terminal Block Connector x 1
• DIO Terminal Block Connector (Female) x 2	

Optional Modules and Accessories

Model No.	Description
MEC-COM-M212-DB9	Mini-PCIe Module with 2x RS-232 Serial Ports, 1x Standard DB9 Cable
MEC-COM-M334-TDB9	Mini-PCIe Module with 4x RS-232/422/485 Serial Ports, 2x Thin DB9 Cable
MEC-LAN-M102-30	Mini-PCIe Module with 2x LAN Ports, 2x 30cm
MEC-USB-M102-30	Mini-PCIe Module with 2x USB 3.2 Gen1 Ports
CFM-IGN100	CFM Module with Power Ignition Sensing Control Function, 12V/24V Selectable (41 x 35 mm)
CFM-PoE100	PoE Control Function Module, Individual Port 25.5W (50 x 44 x 15 mm) (For P2002 only)
CFM-PoE101	PoE Control Function Module, Individual Port 25.5W (50 x 44 x 15 mm) (For P2002E only)

RC-E4-01	Riser Card with 1x PCIe4 Slot(For P2002E only)
RC-PI-01	Riser Card with 1x PCI Slot(For P2002E only)
UB0503	Universal Bracket with 2x DB9 Cutout
UB0504	Universal Bracket with 4x DB9 Cutout
UB0511	Universal Bracket with 2x RJ45 Cutout
UB0514	Universal Bracket with 2x USB Cutout
URM01	Universal 19" Rack Mount Kit for Industrial Panel PC & Industrial Monitor
GST220A24-CIN	Adapter AC/DC 24V 9.2A 220W with 3pin Terminal Block Plug 5.0mm Pitch, with TUBES, GST220A24-CIN
GST120A24-CIN	Adapter AC/DC 24V 5A 120W, GST120A24-CIN, wide temp(-30°C ~ +70°C), level VI
GST60A12-CIN1	Adapter AC/DC 12V 5A 60W, GST60A12-CIN1, wide temp(-30°C ~ +70°C)
SL2-SL3	US 2 heads power cord, US B type to IEC C13,SVT 18AWG/3C Black 1.8M
SL6-SL3	EU 2 heads power cord, EU G type to IEC C13,H05VV-F 0.75mm2/3G Black 1.8M
QP026-SL3	UK 2 heads power cord, UK I type to IEC C13,H05VV-F 0.75mm2/3G Black 1.8M



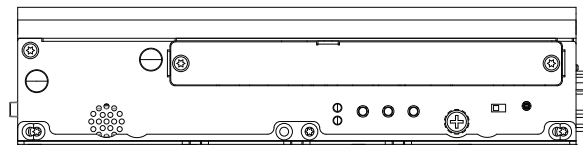

Optional Module Configuration

P2002

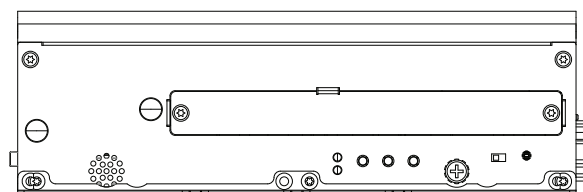

P2002E



Model No.	Description	P2002	P2002E
 <p>MEC-COM-M212/UB0503</p>	Mini-PCIe Module with 2x COM Ports, 1x Universal Bracket with 2x DB9 Cutout (154 x 17 mm)	V	V
 <p>MEC-COM-M334/UB0504</p>	Mini-PCIe Module with 4x RS-232/422/485 Serial Ports, 1x Universal Bracket with 4x DB9 Cutout (154 x 17 mm)	V	V
 <p>MEC-LAN-M102-30/UB0511</p>	Mini-PCIe Module with 2x LAN Ports, 2x 30cm cable, 1x Universal Bracket with 2x RJ45 Cutout (154 x 17 mm)	V	V
 <p>MEC-USB-M102-30/UB0514</p>	Mini-PCIe Module with 2x USB 3.0 Ports, 1x Universal Bracket with 2x USB Cutout (154 x 17 mm)	V	V

V : Compatible