

DX-1300

Intel® Arrow Lake-S Core™ Ultra 200S Series Processors, High Performance and Compact Rugged Embedded Computer

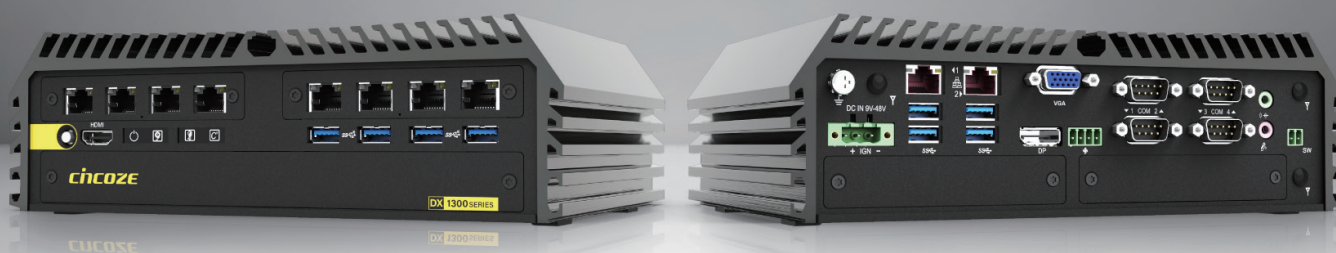

Rugged · Powerful · Compact

DX-1300 Series – Intel Arrow Lake-S Core Ultra Edge Computer

Overview

[CONTACT](#)

The DX-1300 is a compact industrial computer engineered for high-performance edge computing. Powered by an Intel Arrow Lake-S Core™ Ultra 200S series processor, it supports demanding edge applications, including advanced image processing, AI inference, and data integration across multiple tasks. The DX-1300 series packs exceptional computing performance and a rich feature set into a compact chassis while maintaining industrial-grade ruggedness. It is particularly well-suited for high-performance applications with limited installation space and has earned high acclaim in the manufacturing, in-vehicle, and railway markets.

Key Features

- Intel® Arrow Lake-S Core™ Ultra 200S Series (Max 65 W TDP)
- 2x DDR5 SODIMM/CSODIMM Sockets, Up to 6400MHz, 96GB
- Wide Operating Temperature -40°C to 60°C
- Optional CMI Modules for I/O Expansion
- Optional CFM Modules for Hardware TPM, Ignition Sensing & PoE

Certifications



Next-Generation Edge AI Computing Performance

The Intel® Core™ Ultra 200S series processors deliver up to 36 TOPS of AI computing performance through an integrated CPU, GPU, and NPU. This design, specifically for AI acceleration, delivers more than a 3.5x improvement over the previous generation platform.

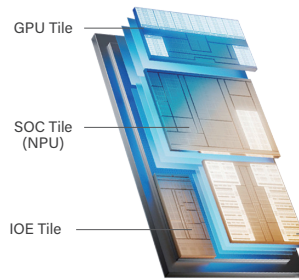

Up to **36** Total Platform TOPS

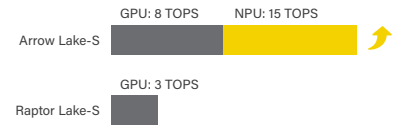

Compact Chassis

Measuring only 242 x 173 x 75mm, the compact chassis has a footprint comparable to an 11-inch iPad. This enables flexible deployment in space-constrained environments such as control cabinets, equipment interiors, or in-vehicle systems.

Rich & Versatile Expandability

Multiple built-in M.2 B/E key slots offer flexible support for wireless communication modules (5G, GNSS, Wi-Fi, Bluetooth), high-speed storage (NVMe SSD), and high-capacity storage (SATA SSD). It also supports I/O expansion modules, allowing for versatile configurations tailored to specific application needs.

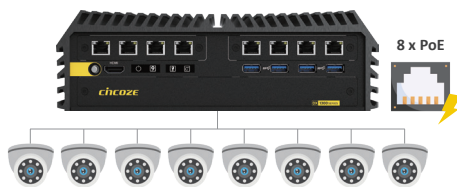

Stable, High-speed Data Transmission

Fast and reliable data transmission is crucial for applications such as image capture and surveillance. The DX-1300 supports multiple high-speed I/O ports, including 10/2.5/1 GbE LAN and USB 3.2. It can be expanded to support up to 12x LAN ports or 8x PoE, effectively simplifying cabling.

Rugged & Multi-vertical Certifications

The rugged design of the DX-1300 complies with military standards (MIL-STD-810H), railway certifications (EN 50121-3-2 & EN 45545-2), ensuring reliable operation in various harsh environments.

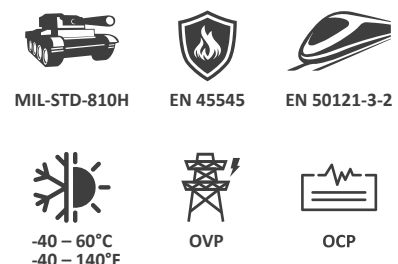

Specifications

Model Name	DX-1300
System	
Processor	<ul style="list-style-type: none"> • Arrow Lake-S Ultra 200S Series CPU: <ul style="list-style-type: none"> - Intel® Core™ Ultra 9 285 24 Cores Up to 5.6 GHz, TDP 65W - Intel® Core™ Ultra 9 285T 24 Cores Up to 5.4 GHz, TDP 35W - Intel® Core™ Ultra 7 265 20 Cores Up to 5.3 GHz, TDP 65W - Intel® Core™ Ultra 7 265T 20 Cores Up to 5.3 GHz, TDP 35W - Intel® Core™ Ultra 5 245 14 Cores Up to 5.1 GHz, TDP 65W - Intel® Core™ Ultra 5 245T 14 Cores Up to 5.1 GHz, TDP 35W - Intel® Core™ Ultra 5 225 10 Cores Up to 4.9 GHz, TDP 65W - Intel® Core™ Ultra 5 225T 10 Cores Up to 4.9 GHz, TDP 35W
Chipset	<ul style="list-style-type: none"> • Intel W880 Chipset
Memory	<ul style="list-style-type: none"> • 2x DDR5 SODIMM/CSODIMM Socket, Support Un-buffered and ECC Type <ul style="list-style-type: none"> - Ultra 9 / 7: Supports Up to 6400MHz, 96GB - Ultra 5: Supports Up to 5600MHz, 96GB
BIOS	<ul style="list-style-type: none"> • AMI BIOS
Graphics	
Graphics Engine	<ul style="list-style-type: none"> • Integrated Intel® X^e LPG Graphics
Maximum Display Output	<ul style="list-style-type: none"> • Supports Three Independent Display
VGA	<ul style="list-style-type: none"> • 1x VGA Connector : 1920 x 1200@60Hz
DP	<ul style="list-style-type: none"> • 1x DP Connector : 4096 x 2304@60Hz <ul style="list-style-type: none"> - Support cable switch HDMI 4096 x 2160@30Hz * Verified maximum resolution: 3840x2160 @60Hz
HDMI	<ul style="list-style-type: none"> • 1x HDMI Connector : 4096x2160@30Hz <ul style="list-style-type: none"> * Verified maximum resolution: 3840x2160 @30Hz
Audio	
Audio Codec	<ul style="list-style-type: none"> • Realtek® ALC888, High Definition Audio
Line-out	<ul style="list-style-type: none"> • 1x Line-out, Phone Jack 3.5mm
Mic-in	<ul style="list-style-type: none"> • 1x Mic-in, Phone Jack 3.5mm
I/O	
LAN	<ul style="list-style-type: none"> • 2x 2.5 GbE LAN, RJ45 <ul style="list-style-type: none"> - GbE1~2: Intel® I226
COM	<ul style="list-style-type: none"> • 4x RS-232/422/485 with Auto Flow Control (Supports 5V/12V), DB9
USB	<ul style="list-style-type: none"> • 4x 10Gbps USB 3.2 Gen2x1, Type A • 4x 5Gbps USB 3.2 Gen1x1, Type A
Storage / Expansion	
2.5" SSD / HDD	<ul style="list-style-type: none"> • 2x 2.5" Front Accessible SATA HDD/SSD Bay (SATA 3.0)
M.2 Key B Socket	<ul style="list-style-type: none"> • 1x M.2 Key B Type 3042/3052 Socket (PCIe Gen 3x2 / USB3.2 Gen1x1 / SATA), Support 5G / GNSS / Storage / Add-on Card Expansion • 1x M.2 Key B Type 2242 Socket (PCIe Gen 4x2 / SATA / USB 2.0), Support Storage / Add-on Card Expansion
M.2 Key E Socket	<ul style="list-style-type: none"> • 1x M.2 Key E Type 2230 Socket (PCIe Gen 3x2 / USB2.0), Support Wireless / Bluetooth / Storage / Intel CNVi Module Expansion
SIM	<ul style="list-style-type: none"> • 1x SIM Socket
CMI (Combined Multiple I/O) Socket	<ul style="list-style-type: none"> • 2x High Speed CMI Interface for optional CMI Module Expansion • 1x Low Speed CMI Interface for optional CMI Module Expansion
CFM (Control Function Module) Socket	<ul style="list-style-type: none"> • 1x CFM-IGN Interface for optional CFM-IGN Module Expansion • 1x CFM-TPM Interface for optional CFM-TPM Module Expansion

Other Function	
RAID	• Support RAID 0/1/5/10
External FAN Connector	• 1x External FAN Connector, 4-pin Terminal Block (Support Smart Fan by BIOS)
Power Ignition Sensing	• Support Power Ignition Sensing Function with Delay Time Management and Selectable 12V/24V (With Optional CFM Module)
TPM	• Support Discrete TPM2.0 (with Optional CFM Module)
Clear CMOS Switch	• 1x Clear CMOS Switch
Reset Button	• 1x Reset Button
Instant Reboot	• Support 0.2sec Instant Reboot Technology
Watchdog Timer	• Software Programmable Supports 256 Levels System Reset
Antenna Holes	• 3
Power	
Power Button	• 1x ATX Power On/Off Button
Power Mode Switch	• 1x AT/ATX Mode Switch
Power Input	• 9-48VDC, 3-pin Terminal Block
Remote Power On/Off	• 1x Remote Power On/Off, 2-pin Terminal Block
Remote Power LED	• 1x Remote Power LED, 2-pin Terminal Block
Max. Power Consumption	<ul style="list-style-type: none"> • 35W CPU: 162W • 65W CPU: 272.88W - Test conducted with CPU, 1x RAM, and 1x storage - 100% load during burn-in test
Inrush Current (Peak)	<ul style="list-style-type: none"> • 35W CPU: 5.24 A@24V • 65W CPU: 4.939 A@24V
Physical	
Dimension (W x D x H)	• 242.2 x 173 x 75mm
Weight Information	• 3.59 kg
Mechanical Construction	• Extruded Aluminum with Heavy Duty Metal
Mounting	• Wall / DIN-RAIL / VESA / Side Mount
Physical Design	<ul style="list-style-type: none"> • Fanless Design • Cableless Design • Jumper-less Design • Unibody Design
Reliability & Protection	
Reverse Power Input Protection	• Yes
Over Voltage Protection	<ul style="list-style-type: none"> • Protection Range: 51~58V • Protection Type: shut down operating voltage, re-power on at the preset level to recover
Over Current Protection	• 15A
CMOS Battery Backup	• SuperCap Integrated for CMOS Battery Maintenance-free Operation
MTBF	<ul style="list-style-type: none"> • 332,808 Hours - Database: Telcordia SR-332 Issue3, Method 1, Case 3
Operating System	
Windows	• Windows®11, Windows® 10
Linux	• Ubuntu 24.04

Environment	
Operating Temperature	<ul style="list-style-type: none"> • 35W TDP Processor: -40°C to 60°C (-40°F to 140°F) • 65W TDP Processor: -40°C to 50°C (-40°F to 122°F) With External Fan Kit <ul style="list-style-type: none"> - With extended temperature peripherals; Ambient with air flow - According to IEC60068-2-1, IEC60068-2-2, IEC60068-2-14
Storage Temperature	<ul style="list-style-type: none"> • -40°C to 85°C (-40°F to 185°F)
Relative Humidity	<ul style="list-style-type: none"> • 95%@60°C (non-Condensing)
Shock	<ul style="list-style-type: none"> • MIL-STD-810H
Vibration	<ul style="list-style-type: none"> • MIL-STD-810H
EMC	<ul style="list-style-type: none"> • CE, UKCA, FCC, ICES-003 Class A
EMI	<ul style="list-style-type: none"> • CISPR 32 Conducted & Radiated: Class A • EN/BS EN 50121-3-2 Conducted & Radiated: Class A • EN/BS EN IEC 61000-3-2 Harmonic current emissions: Class A • EN/BS EN61000-3-3 Voltage fluctuations & flicker • FCC 47 CFR Part 15B, ICES-003 Conducted & Radiated: Class A
EMS	<ul style="list-style-type: none"> • EN/IEC 61000-4-2 ESD: Contact: 6 kV; Air: 8 kV • EN/IEC 61000-4-3 RS: 80 MHz to 1000 MHz: 20 V/m • EN/IEC 61000-4-4 EFT: AC Power: 2 kV; DC Power: 1 kV; Signal: 2 kV • EN/IEC 61000-4-5 Surges: AC Power: 2 kV; Signal: 1 kV • EN/IEC 61000-4-6 CS: 10V • EN/IEC 61000-4-8 PF: 50 Hz, 30A/m • EN/IEC 61000-4-11 Voltage Dips & Voltage Interruptions: 1 cycles at 60 Hz
Railway	<ul style="list-style-type: none"> • EMC: <ul style="list-style-type: none"> EN 50155: 2021 Clause 4.4.6, 13.4.9 - EN 50121-1 : 2017 - EN 50121-3-2: 2016 + A1: 2019
Fire Protection	<ul style="list-style-type: none"> • EN 45545-2
Safety	<ul style="list-style-type: none"> • UL, cUL, CB, IEC, EN 62368-1

External Layout

Front I/O

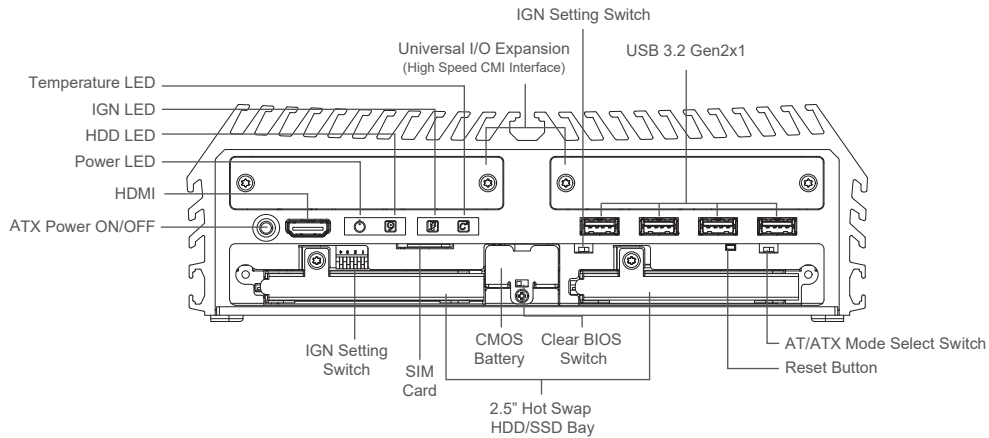

Rear I/O

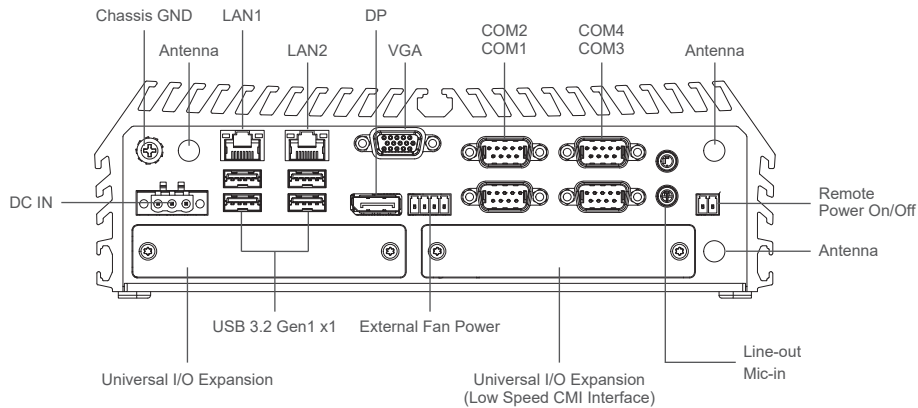

Dimensions

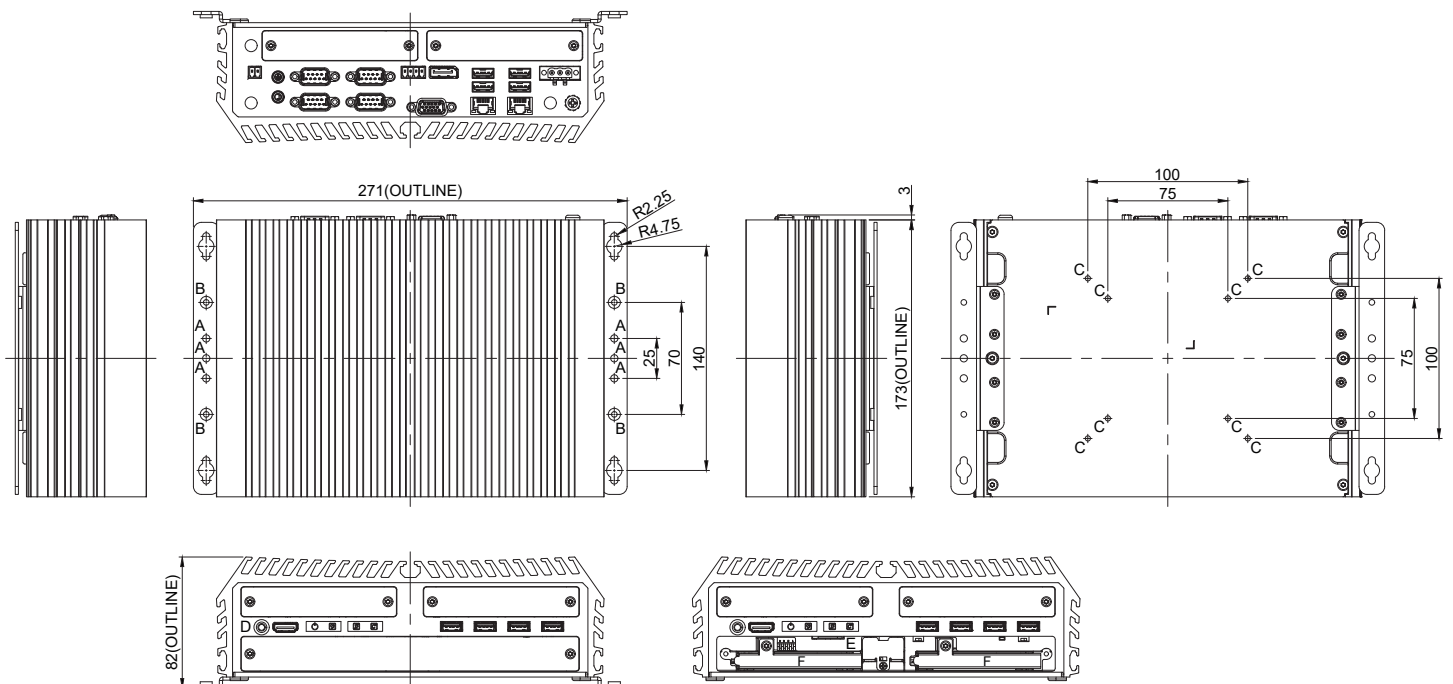

Unit: mm

Ordering Information

Available Models

Model No.	Description
DX-1300-R10	Intel® Arrow Lake-S Core™ Ultra 200S Series Processors, High Performance and Compact Rugged Embedded Computer

Package Checklist









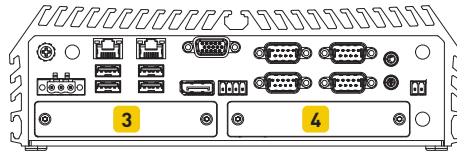
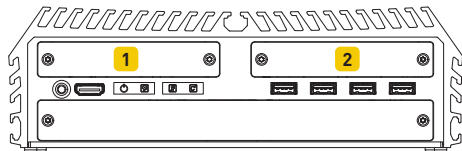





• DX-1300 Series Embedded System x1	• Power Terminal Block Connector x1
• CPU Heatsink Pack x1	• Remote Power On/Off Terminal Block Connector x 1
• Screw Pack x 1	• Fan Terminal Block Connector x 1
• Wall Mounting Kit x1	• M.2 Key B Type 3052 to 3042 Adapter Bracket x1

Optional Modules and Accessories

Model No.	Description
CFM-PoE01	CFM Module with PoE Control Function, Individual Port 25.5W
CFM-IGN01	CFM Module with Power Ignition Sensing Control Function, 12V/24V Selectable
CFM-TPM02-R10	CFM Module with Hardware TPM 2.0
CMI-LAN01-R12	CMI Module with 4x RJ45 Intel I210 1GbE LAN Ports
CMI-M12LAN01-R12	CMI Module with 4 x M12 Intel I210 1GbE LAN Ports
CMI-XM12LAN01-R10	CMI Module with M12 X-Coded Connector, 4x Intel I210 1GbE LAN Ports
CMI-2P5GLAN01-R10	CMI Module with 4x Intel 2.5GbE LAN, RJ45 Port
CMI-10GLAN05-R10	CMI Module with 2x Intel 10GbE LAN, RJ45 Port
CMI-10GXM12LAN01-R10	CMI Module with 2x Intel 10GbE LAN, M12 X-Coded Connector
CMI-CAN01-R10	CMI Module with 2x CAN FD Ports
CMI-DIO01	CMI Module with 16DIO (8in 8out)
CMI-COM01	CMI Module with 2x RS232/422/485 (Support 5V/12V)
MEC-CAN-2812i	M.2 2242/2260/2280 (B+M key) dual isolated CAN bus 2.0B board (-40°C~+85°C), 2x DB9 Connector, Cervoz
MEC-CAN-2814i	M.2 2242/2260/2280 (B+M key) quad isolated CAN bus 2.0B board (-40°C~+85°C), 4x DB9 Connector, Cervoz
MEC-COM-2012	M.2 2242/2260/2280 (B+M key) 2-port RS-232 serial board (-40°C~+85°C), 2x DB9 Connector, Cervoz
MEC-COM-2032i	M.2 2242/2260/2280 (B+M key) 2-port RS-232/422/485 isolated serial board (-40°C~+85°C), 2x DB9 Connector, Cervoz
MEC-LAN-2002i	M.2 2242/2260/2280 (B+M key) 2-port 10/100/1000 isolated Ethernet board(-40°C~+85°C), 2x RJ45 Connector, Cervoz
MEC-LAN-2002i-S	M.2 2242/2260/2280 (B+M key) 2-port 10/100/1000 isolated Ethernet board(0°C~+70°C), 2x RJ45 Connector, Cervoz
UB0930-R10	Universal Bracket with 4x M12 X-Coded Cutout
UB0932-R10	Universal Bracket with 3x Antenna Cutout
UB1303	Universal Bracket with 2x DB9 Cutout
UB1311	Universal Bracket with 2x RJ45 Cutout for MEC-LAN Expansion
UB1318	Universal Bracket with DIO Cutout
UB1710-R10	Universal Bracket with 4x M12 A-Coded Cutout
UB1712-R10	Universal Bracket with 4x RJ45 Cutout
UB1728-R10	Universal Bracket with 2x RJ45 Cutout for CMI-10GLAN Expansion
UB1737-R10	Universal Bracket with 2x M12 X-coded Cutout
UB1738-R10	Universal Bracket with 2x DB9 and 1x Switch Cutout for CMI-CAN Expansion
AC-BE01-R10	M.2 Key B Type 2242 to M.2 Key E Type 2230 Adapter Card
SIDE-DX	DX Series side mount kit
DIN01	DIN-RAIL Mount Kit, KMRH-K175
GST220A24-CIN	Adapter AC/DC 24V 9.2A 220W with 3pin Terminal Block Plug and Tubes, Level VI
GST360A24-CIN	Adapter AC/DC 24V 15A 360W with 3pin Terminal Block Plug and TUBES, Level VI
RSD-200D-24	Railway Single Output DC-DC Converter 200W / DC 24V
FAN-EX101	External Fan with 4pin Terminal Block Plug and Mounting Bracket, Support smart fan

Optional Module Configuration



Model No.	Description	1	2	3	4
UB0932-R10 	Universal Bracket with 3x Antenna Cutout	V	V	V	V
CMI-LAN01-R12/UB1712-R10 	CMI Module with 4x Intel I210 1GbE LAN, RJ45 Port / Universal Bracket with 4x RJ45 Cutout	V	V	-	-
CMI-2P5GLAN01-R10/UB1712-R10 	CMI Module with 4x Intel 2.5GbE LAN, RJ45 Port / Universal Bracket with 4x RJ45 Cutout	V	V	-	-
CMI-10GLAN05-R10/UB1728-R10 	CMI Module with 2x Intel 10GbE LAN, RJ45 Port/ Universal Bracket with 2x RJ45 Cutout	V	V	-	-
CMI-M12LAN01-R12/UB1710-R10 	CMI Module with M12 Connector, 4x Intel 1GbE LAN / Universal Bracketwith 4x M12 A-Coded Cutout	V	V	-	-
CMI-XM12LAN01-R10/UB0930-R10 	CMI Module with M12 X-Coded Connector, 4x Intel I210 1GbE LAN Ports / Universal Bracket with 4x M12 X-Coded Cutout	V	V	-	-
CMI-10GXM12LAN01-R10/UB1737-R10 	CMI Module with 2x Intel 10GbE LAN, M12 X-Coded Connector / Universal Bracket with 2x M12 X-coded Cutout	V	V	-	-
CMI-CAN01-R10 /UB1738-R10 	CMI Module with 2x CAN FD Ports / Universal Bracket with 2x DB9 and 1x Switch Cutout for CMI-CAN Expansion	V	V	-	-
CMI-DIO01/UB1318 	CMI Module with 16DIO (8in 8out) / Universal Bracket with DIO Cutout	-	-	-	V
CMI-COM01/UB1303 	CMI Module with 2x RS232/422/485 (Support 5V/12V) / Universal Bracket with 2x DB9 Cutout	-	-	-	V
MEC-COM-2012/UB1303 	M.2 Module with 2x RS-232 Ports, 1x Standard DB9 Cable / Universal Bracket with 2x DB9 Cutout	-	-	V	-
MEC-COM-2032i/UB1303 	M.2 Module with 2x RS-232/422/485 Ports, 1x Standard DB9 Cable / 2x Universal Bracket with 2x DB9 Cutout	-	-	V	-
MEC-CAN-2812i/UB1303 	M.2 Module with 2x isolated CAN bus 2.0B Ports, 2x Standard DB9 Cable / Universal Bracket with 2x DB9 Cutout	-	-	V	V
MEC-CAN-2814i/2xUB1303 	M.2 Module with 4x isolated CAN bus 2.0B Ports, 4x Standard DB9 Cable / 2x Universal Bracket with 2x DB9 Cutout	-	-	V	-
MEC-LAN-2002i(-S)/UB1311 	M.2 Module with 2x LAN Ports, 2x 30cm cable / Universal Bracket with 2x RJ45 Cutout for MEC-LAN Expansion	-	-	V	-

V : Compatible

Updated: Apr. 13, 2026.