

MIC-730AI

AI Inference System Based on NVIDIA Jetson® AGX Xavier



Features

- Fanless compact design
- Embedded with NVIDIA® Jetson™ AGX Xavier up to 32 TOPS
- Supports 2 x GbE, 2 x USB 3.0, 2 x USB 2.0, 2 x RS-232/422/485
- Supports 1 x mPCIe, 1 x M.2 2280 (PCIe x2 NVMe), PCIe Add-on Card
- Supports Allxon 24/7 remote monitoring and OTA deployment; Azure Certified Devices

Specifications

		Jetson AGX Xavier
Processor System	CPU	8-core NVIDIA Carmel ARM® v8.2 64-bit CPU
	GPU	512-core NVIDIA Volta GPU with 64 Tensor Cores
	Memory	32GB 256-bit LPDDR4
	Storage	32GB eMMC 5.1
I/O	Ethernet	2 x 10/100/1000 Mbps
	Display	HDMI (Max. resolution 3840x2160 @ 60Hz)
	USB	Internal: 1 x USB 2.0 External: 2 x USB 2.0, 2 x USB 3.0
	Digital I/O	8-ch DI, 8-ch DO
	Power Switch	1 x Power ON/OFF Button
	COM	2 x RS-232/RS-422/RS-485
	OTG USB	1 x Micro USB (Internal)
Expansion	iModule (Optional)	1 x PCIe x8 slot (x8 link), via MIC-75M10-00A1 1 x PCIe x16 slot (x8 link) + 1 x PCIe x4 slot (x4 link), via MIC-75M20-00C1
	SIM	1 x Nano SIM slot
	iDoor (Optional)	1 x iDoor bracket reserve
	Mini PCIe	1 x mPCIe (Signal: PCIe+USB)
Storage	Storage	1 x internal 2.5" HDD/SSD (Max. 9.5mm height) 1 x M.2 2280 (M-Key, NVMe, Signal: PCIe x2)
Power	Type	AT/ATX (Default AT)
	Input Voltage	9 ~ 36 V _{DC} , 11-3A
Environment	Operating Temperature	MODE_30W_ALL: -10 ~ +55 °C with 0.7 m/s airflow MAXN: -10 ~ +55 °C with 0.7 m/s airflow
	Operating Humidity	95% @ 40 °C (non-condensing)
	Shock	10G / 11 ms
	Vibration	0.5Grms @ 5 ~ 500 Hz, random, 1 hr/axis (With HDD)
Mechanical	Dimensions (W x D x H)	Core Module: 192 x 230 x 87 mm (7.55" x 9.05" x 3.43")
	Weight	4.5 kg
	Installation	Desktop / Wall mount
BSP	Jetpack	4.6
Certifications		UL/CB/CE/FCC/BSMI/CCC (No RED certification)

Dimensions

Unit: mm

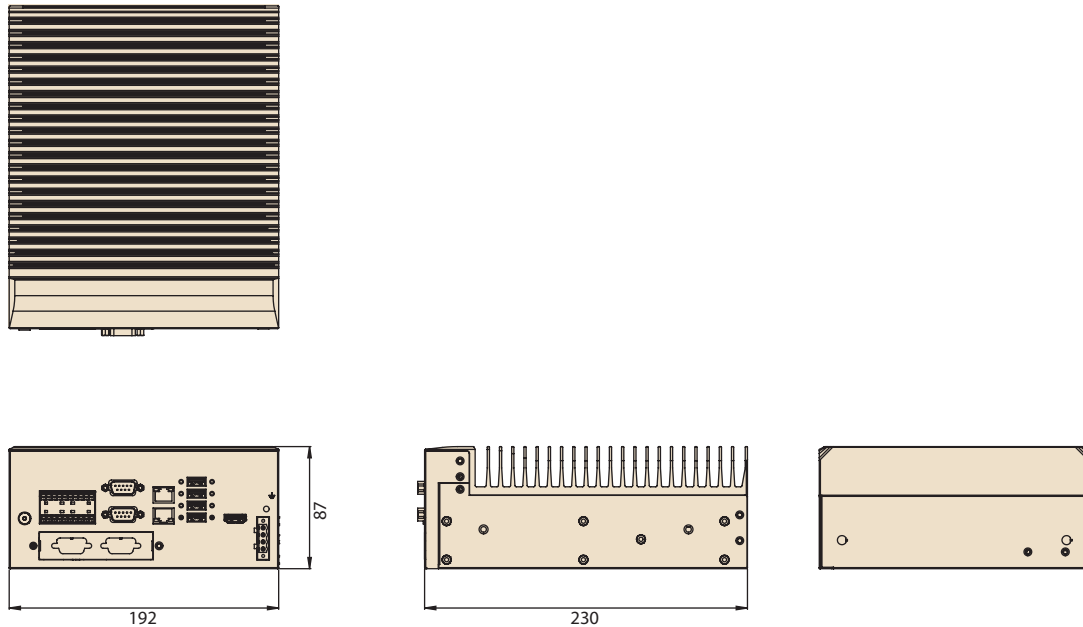

Ordering Information

Part Number	NVIDIA Module	Memory	eMMC	SD Card
MIC-730AI-10A1	AGX Xavier	32G	32G	YES
MIC-730AI-10A2	AGX Xavier	32G	32G	-

Packing List

Part Number	Description	Quantity
1652003234	Power terminal block 4P	1
1652010202	DI/DO terminal block 10P	2
1700013095-01	SATA cable	1
1700023619-01	Micro USB cable for system recovery	1
1700024372-01	SATA power cable	1
1960070543T007	Mounting bracket	2
1990008871S000	2.5 HDD Rubber	4
1930008089	Mini PCIe screw	2
1930005673-11	M.2 screw	1

Optional

Part Number	Description
96PSA-A230W24P4-3	Adaptor A/D, 100-240V, 230W, 24V
96PSA-A150W19P4-3	Adaptor A/D, 100-240V, 150W, 19V
1702002600	Power Cord (USA) UL/CSA, 3-pin, 10A, 125V, 1.83 M, 180 D
1700029019-01	Power Cord (PSE/BSMI), 3-pin, 7A, 125V, 1.8m, DAC-ST01
1702002605	Power Cord (EU) 2-pin, 10/16A, 220V, 1.83 M, 90 D
1960065854N001	PCM series module bracket
MIC-75M10-00A1	iModule (1 x PCIe x8)
MIC-75M20-00C1	iModule (1 x PCIe x16 + 1 x PCIe x4 , x16 slot, x8 lanes)
98RV710AL00	Allxon OOB module

Front View

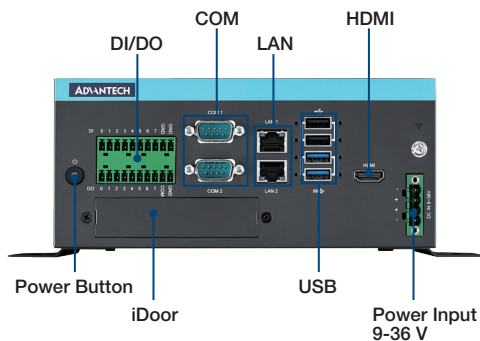

Remote Management Enrollment

Enroll in 24/7 secure service to get all the features of remote device management on one centralized cloud portal - Allxon Portal.

**Supports JetPack 4.4GA and above

Enrollment Page: https://allxon.com/jetson/device_enroll/