

chcoze

DS-1400 Series

User Manual



Rugged Embedded Computer

12th Generation Intel® Core™ Series Processors, High Performance,
Expandable and Modular Rugged Embedded Computer

Contents

Preface.....	5
Revision	5
Copyright Notice	5
Acknowledgement	5
Disclaimer.....	5
Declaration of Conformity.....	5
FCC.....	5
CE.....	6
UL.....	6
Product Warranty Statement	6
Warranty	6
RMA.....	6
Limitation of Liability.....	7
Technical Support and Assistance	7
Conventions Used in this Manual	7
Safety Precautions.....	8
Ordering Information	9
Chapter 1 Product Introductions	11
1.1 Overview	12
1.2 Specifications	14
1.3 External Layout.....	17
1.3.1 Front.....	17
1.3.2 Rear	18
1.4 Dimensions.....	19
Chapter 2 Introduction to Switches and Connectors.....	21
2.1 Location of Switches and Connectors	22
2.1.1 Top View	22
2.1.2 Bottom View.....	23
2.2 Switches and Connectors Definition	24
2.3 Definition of Switches	26
2.4 Definition of Connectors	28
2.5 Optional Module Pin Definition & Settings.....	35
2.5.1 CMI-M12LAN01-R12/UB1010 Module	35
2.5.2 CMI-XM12LAN01-R12/UB1030 Module	35
2.5.3 CMI-DIO02/UB1018 Module.....	36
2.5.4 CMI-COM02/UB1004 Module.....	37
2.5.5 CMI-ICOM01/UB1004 Module.....	38

2.5.6 CFM-IGN101 Module	39
Chapter 3 System Setup	40
3.1 Removing Top Cover.....	41
3.2 Installing CPU	43
3.3 Installing SO-DIMM	46
3.4 Installing Mini-PCle Card	48
3.5 Installing M.2 M Key Card	49
3.6 Installing Antenna	50
3.7 Installing SATA Hard Drive on Top Side.....	52
3.8 Installing PCI/PCle Add-on Card	53
3.9 Assembling Top Cover	57
3.10 Installing SATA Hard Drives at Front Panel	59
3.11 Installing SIM Card.....	61
3.12 Replacing CMOS Battery	62
3.13 Installing Wall Mount	64
3.14 Connecting to Power Supply	66
3.15 Installing CMI Modules	67
3.15.1 CMI-LAN01-R12/UB1012 Module.....	67
3.15.2 CMI-M12LAN01-R12/UB1010 Module	68
3.15.3 CMI-XM12LAN01-R10/UB1030 Module	70
3.15.4 CMI-10GLAN03-R10/UB1028 Module	73
3.15.5 CMI-DIO02/UB1018 Module.....	76
3.15.6 CMI-COM02/UB1004 Module.....	77
3.15.7 CMI-ICOM01/UB1004 Module.....	79
3.16 Installing CFM Modules.....	81
3.16.1 CFM-PoE03 Module	81
3.16.2 CFM-IGN101 Module	85
3.17 Installing MEC Modules.....	86
3.17.1 MEC-COM-M212-DB9/UB0303 Module	86
3.17.2 MEC-USB-M102-30/UB0314 Module	89
3.17.3 MEC-LAN-M102-30/UB0311 Module	92
3.18 Installing External FAN	95
3.19 Installing Internal FAN	97
Chapter 4 BIOS Setup	99
4.1 BIOS Introduction.....	100
4.2 Main Setup	101
4.3 Advanced Setup	102
4.3.1 CPU Configuration.....	102
4.3.2 Power & Performance.....	104

4.3.3 SATA Configuration	104
4.3.4 PCH-FW Configuration	105
4.3.5 Trusted Computing	106
4.3.6 ACPI Settings	107
4.3.7 F81966 Super IO Configuration	108
4.3.8 Hardware Monitor	109
4.3.9 S5 RTC Wake Settings	110
4.3.10 Serial Port Console Redirection	110
4.3.11 USB Configuration	111
4.3.12 Network Stack Configuration	111
4.3.13 CSM Configuration	112
4.3.14 NVMe Configuration	112
4.4 Chipset Setup	113
4.4.1 System Agent (SA) Configuration	113
4.4.2 PCH-IO Configuration	117
4.5 Security Setup	120
4.5.1 Administrator Password	120
4.5.2 User Password	120
4.5.3 Security Boot	120
4.6 Boot Setup	121
4.6.1 Setup Prompt Timeout [1]	121
4.6.2 Bootup NumLock State [Off]	121
4.6.3 Quiet Boot [Disabled]	121
4.6.4 Fast Boot [Disabled]	121
4.7 Save & Exit	122
4.7.1 Save Changes and Exit	122
4.7.2 Discard Changes and Exit	122
4.7.3 Save Changes and Reset	122
4.7.4 Discard Changes and Reset	122
4.7.5 Save Changes	122
4.7.6 Discard Changes	122
4.7.7 Restore Defaults	122
4.7.8 Save as User Defaults	122
4.7.9 Restore User Defaults	122
4.8 MEBx	123
Chapter 5 Product Application	126
5.1 Where to download drivers?	127
5.2 Where to find the technical documents?	127

Preface

Revision

Revision	Description	Date
1.00	First Released	2023/08/31
1.01	Correction Made	2023/09/22
1.02	Correction Made	2023/12/08

Copyright Notice

© 2023 by Cincoze Co., Ltd. All rights are reserved. No parts of this manual may be copied, modified, or reproduced in any form or by any means for commercial use without the prior written permission of Cincoze Co., Ltd. All information and specification provided in this manual are for reference only and remain subject to change without prior notice.

Acknowledgement

Cincoze is a registered trademark of Cincoze Co., Ltd. All registered trademarks and product names mentioned herein are used for identification purposes only and may be trademarks and/or registered trademarks of their respective owners.

Disclaimer

This manual is intended to be used as a practical and informative guide only and is subject to change without notice. It does not represent a commitment on the part of Cincoze. This product might include unintentional technical or typographical errors. Changes are periodically made to the information herein to correct such errors, and these changes are incorporated into new editions of the publication.

Declaration of Conformity



FCC

This equipment has been tested and found to comply with the limits for a Class A digital device, pursuant to Part 15 of the FCC Rules. These limits are designed to provide reasonable protection against harmful interference when the equipment is operated in a commercial environment. This equipment generates, uses, and can radiate radio frequency energy and, if not installed and used in accordance with the instruction manual, may cause harmful interference to radio communications. Operation of this equipment in a residential area is likely to cause harmful interference in which case the user will be required to correct the interference at his

own expense.



CE

The product(s) described in this manual complies with all application European Union (CE) directives if it has a CE marking. For computer systems to remain CE compliant, only CE-compliant parts may be used. Maintaining CE compliance also requires proper cable and cabling techniques.



UL

A product that carries the “UL Listed” approval mark means that the product has been tested by UL to nationally recognized Safety Standards and has been found to be free from reasonably foreseeable risk of fire, electric shock and related hazards

Product Warranty Statement

Warranty

Cincoze products are warranted by Cincoze Co., Ltd. to be free from defect in materials and workmanship for 2 years from the date of purchase by the original purchaser. During the warranty period, we shall, at our option, either repair or replace any product that proves to be defective under normal operation. Defects, malfunctions, or failures of the warranted product caused by damage resulting from natural disasters (such as by lightning, flood, earthquake, etc.), environmental and atmospheric disturbances, other external forces such as power line disturbances, plugging the board in under power, or incorrect cabling, and damage caused by misuse, abuse, and unauthorized alteration or repair, and the product in question is either software, or an expendable item (such as a fuse, battery, etc.), are not warranted.

RMA

Before sending your product in, you will need to fill in Cincoze RMA Request Form and obtain a RMA number from us. Our staff is available at any time to provide you with the most friendly and immediate service.

■ RMA Instruction

- Customers must fill in Cincoze Return Merchandise Authorization (RMA) Request Form and obtain an RMA number prior to returning a defective product to Cincoze for service.
- Customers must collect all the information about the problems encountered and note anything abnormal and describe the problems on the “Cincoze Service Form” for the RMA number apply process.
- Charges may be incurred for certain repairs. Cincoze will charge for repairs to products whose warranty period has expired. Cincoze will also charge for repairs to products if the damage resulted from acts of God, environmental or atmospheric disturbances, or other external forces through misuse, abuse, or unauthorized

alteration or repair. If charges will be incurred for a repair, Cincoze lists all charges, and will wait for customer's approval before performing the repair.

- Customers agree to ensure the product or assume the risk of loss or damage during transit, to prepay shipping charges, and to use the original shipping container or equivalent.
- Customers can be sent back the faulty products with or without accessories (manuals, cable, etc.) and any components from the system. If the components were suspected as part of the problems, please note clearly which components are included. Otherwise, Cincoze is not responsible for the devices/parts.
- Repaired items will be shipped along with a "Repair Report" detailing the findings and actions taken.

Limitation of Liability

Cincoze' liability arising out of the manufacture, sale, or supplying of the product and its use, whether based on warranty, contract, negligence, product liability, or otherwise, shall not exceed the original selling price of the product. The remedies provided herein are the customer's sole and exclusive remedies. In no event shall Cincoze be liable for direct, indirect, special or consequential damages whether based on contract of any other legal theory.

Technical Support and Assistance

1. Visit the Cincoze website at www.cincoze.com where you can find the latest information about the product.
2. Contact your distributor or our technical support team or sales representative for technical support if you need additional assistance. Please have following information ready before you call:
 - Product name and serial number
 - Description of your peripheral attachments
 - Description of your software (operating system, version, application software, etc.)
 - A complete description of the problem
 - The exact wording of any error messages

Conventions Used in this Manual



WARNING
(AVERTIR)

This indication alerts operators to an operation that, if not strictly observed, may result in severe injury.

(Cette indication avertit les opérateurs d'une opération qui, si elle n'est pas strictement observée, peut entraîner des blessures graves.)



**CAUTION
(ATTENTION)**

This indication alerts operators to an operation that, if not strictly observed, may result in safety hazards to personnel or damage to equipment.
(Cette indication avertit les opérateurs d'une opération qui, si elle n'est pas strictement observée, peut entraîner des risques pour la sécurité du personnel ou des dommages à l'équipement.)



**NOTE
(NOTE)**

This indication provides additional information to complete a task easily.
(Cette indication fournit des informations supplémentaires pour effectuer facilement une tâche.)

Safety Precautions

Before installing and using this device, please note the following precautions.

1. Read these safety instructions carefully.
2. Keep this User's Manual for future reference.
3. Disconnect this equipment from any AC outlet before cleaning.
4. For plug-in equipment, the power outlet socket must be located near the equipment and must be easily accessible.
5. Keep this equipment away from humidity.
6. Put this equipment on a reliable surface during installation. Dropping it or letting it fall may cause damage.
7. Make sure the voltage of the power source is correct before connecting the equipment to the power outlet.
8. Use a power cord that has been approved for using with the product and that it matches the voltage and current marked on the product's electrical range label. The voltage and current rating of the cord must be greater than the voltage and current rating marked on the product.
9. Position the power cord so that people cannot step on it. Do not place anything over the power cord.
10. All cautions and warnings on the equipment should be noted.
11. If the equipment is not used for a long time, disconnect it from the power source to avoid damage by transient overvoltage.
12. Never pour any liquid into an opening. This may cause fire or electrical shock.
13. Never open the equipment. For safety reasons, the equipment should be opened only by qualified service personnel.

If one of the following situations arises, get the equipment checked by service personnel:

- The power cord or plug is damaged.
- Liquid has penetrated into the equipment.
- The equipment has been exposed to moisture.
- The equipment does not work well, or you cannot get it work according to the user's

manual.

- The equipment has been dropped and damaged.
 - The equipment has obvious signs of breakage.
14. CAUTION: Risk of Explosion if Battery is replaced by an Incorrect Type. Dispose of Used Batteries According to the Instructions.
ATTENTION: Risque d'explosion si la batterie est remplacée par un type incorrect. Mettre au rebus les batteries usagées selon les instructions.
15. Equipment intended only for use in a RESTRICTED ACCESS AREA.
16. Output of the external power source shall be complied with ES1, PS3 requirements, output rating between 9-48 VDC, minimum 9-2A, with minimum rated maximum ambient temperature 70°C, and has to be evaluated according to UL/IEC/EN 60950-1 and/or UL/IEC/EN 62368-1. If need further assistance, please contact Cincoze for further information.
17. Ensure to connect the power cord of power adapter to a socket-outlet with earthing connection.
18. Dispose of used battery promptly. Keep away from children. Do not disassemble and do not dispose of in fire.

Package Checklist

Item	Description	Q'ty
1	Embedded System	1
2	Heatsink Pack	1
3	Wall Mount Kit	1
4	Screw Pack	1
5	Power Terminal Block Connector	1
6	Remote Function Terminal Block Connector	2
7	Fan Terminal Block Connector	1

Note: Notify your sales representative if any of the above items are missing or damaged.

Ordering Information

Model No.	Product Description
DS-1400-R10	12th Generation Intel Core Series Processors, High Performance, Expandable and Modular Rugged Embedded Computer
DS-1401-R10	12th Generation Intel Core Series Processors, High Performance, Expandable and Modular Rugged Embedded Computer with 1x PCI/PCIe Expansion Slot

DS-1402-R10

12th Generation Intel Core Series Processors, High Performance, Expandable
and Modular Rugged Embedded Computer with 2x PCI/PCIe Expansion Slot



Chapter 1

Product Introductions

1.1 Overview

The DS-1400 series is a high-performance, expandable, and rugged embedded computer, boasting outstanding performance as well as rich industrial I/O interfaces and robust functionalities. To meet various application needs, it can flexibly expand the required I/O and specific functions through Cincoze’s unique CMI, CFM, and MEC expansion modules. Moreover, the DS-1400 has passed multiple international certifications, ensuring stable and reliable performance in diverse harsh environments. It is an ideal choice for manufacturing and railway applications.

- Intel® 12th Gen Alder Lake-S Core™ i9/i7/i5/i3 Processors (max 65 W TDP)
- 2x DDR5 SO-DIMM Sockets, Supports ECC/non ECC type Memory, Up to 4800MHz, 64GB
- 2x GbE LAN and optional 2x 10GbE LAN
- 2x 2.5" SATA storage, 3x mSATA sockets, 1x M.2 key M for NVMe SSD
- 1x PCI/PCIe expansion slots (DS-1401 only), 2x PCI/PCIe expansion slots (DS-1402 only)
- Optional CMI modules for I/O expansion
- Optional CFM modules for ignition sensing & PoE
- Wide operating temperature -40°C to 70°C
- MIL-STD-810G military standard and EN50155 (EN 50121-3-2 only)
- Safety: UL, cUL, CB, IEC, EN 62368-1

Rapid Processing and Inference

The DS-1400 supports 12th gen Intel® Core™ i9/i7/i5/i3 (Alder Lake-S) processors based on the Intel 7 process, with up to 16 cores (8P + 8E) and 24 threads, delivering more than 1.35x the speed of Comet Lake-S platform. The Intel® Xe architecture of the UHD 770 graphics chip boosts GPU image classification inference performance to 2.8x the speed of Comet Lake-S, providing the processing performance needed for AI and edge computing.

CPU Performance



Alder Lake-S

GPU Image Classification Inference Performance

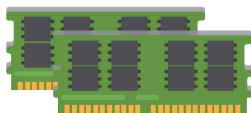

DDR5 ECC Memory

High-speed, Safe Memory

Two DDR5 SO-DIMM slots support up to 64GB of 4800MHz memory and include ECC (Error Correction Code) technology, giving the extra stability and reliability needed for industrial automation applications.



Industrial I/O and Modular Expansion

The DS-1402 offers a vast array of industrial-focused I/O including up to 2x GbE LAN, 6x USB 3.2, and 2x USB 2.0, 2x RS232/422/485, 2x 2.5" SATA, 3x mSATA, 1x M.2 key M for NVMe SSD, 2x SIM card slots, 3x full-size Mini-PCIe and quad independent displays (DisplayPort, HDMI, VGA). It also features modular expansion through Cincoze's CMI/CFM modules, adding additional I/O or other functionality such as high-speed 10GbE LAN, PoE, and IGN (power ignition sensing).

PCI/PCIe

Add-on Cards

The DS-1402 accommodates dual PCI/PCIe expansion slots. It can support a maximum of one 110W add-on card with dimensions of 111 x 235 mm. This flexible slot allows integration of I/O, GPU, image capture, data acquisition, and motion control cards to suit specific application needs.

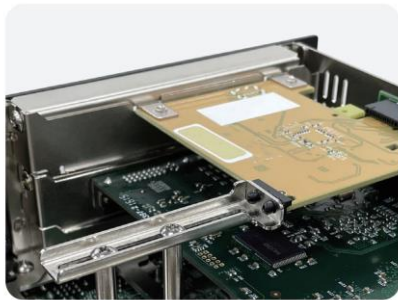

Adjustable

PCIe Card Retainer

A patented adjustable PCIe card retainer can securely fasten add-on cards. This unique design effectively prevents the cards from loosening due to vibrations in high-vibration environments, ensuring the stable operation of the system.

Patent No. 1773359

Robust and Reliable

The DS-1400 is built tough, reflected in its industrial-grade protection design and industry certifications in different fields. In addition to features such as wide temperature (-40 - 70°C), wide voltage input (9 - 48 VDC), overvoltage, overcurrent, and ESD protection, it also complies with the US military shock vibration standard MIL-STD-810G. Product safety and reliability are further ensured with internationally recognized UL 62368-1 safety certification. For more secure railway computing, it also passes the EMC EN 50121-3-2 standard in EN 50155.



1.2 Specifications

Model Name	DS-1400 Series
System	
Processor	<ul style="list-style-type: none"> 12th Generation Intel® Alder Lake-S Series CPU: <ul style="list-style-type: none"> - Intel® Core™ i9-12900E 16 Cores Up to 5 GHz, TDP 65W - Intel® Core™ i7-12700E 12 Cores Up to 4.8 GHz, TDP 65W - Intel® Core™ i5-12500E 6 Cores Up to 4.5 GHz, TDP 65W - Intel® Core™ i3-12100E 4 Cores Up to 4.2 GHz, TDP 60W - Intel® Core™ i9-12900TE 16 Cores Up to 4.8 GHz, TDP 35W - Intel® Core™ i7-12700TE 12 Cores Up to 4.7 GHz, TDP 35W - Intel® Core™ i5-12500TE 6 Cores Up to 4.3 GHz, TDP 35W - Intel® Core™ i3-12100TE 4 Cores Up to 4.0 GHz, TDP 35W - Intel® Pentium® G7400E 2 Cores Up to 3.6 GHz, TDP 46W - Intel® Pentium® G7400TE 2 Cores Up to 3.0 GHz, TDP 35W - Intel® Celeron® G6900E 2 Cores Up to 3.0 GHz, TDP 46W - Intel® Celeron® G6900TE 2 Cores Up to 2.4 GHz, TDP 35W
Chipset	<ul style="list-style-type: none"> Intel R680E Chipset
Memory	<ul style="list-style-type: none"> 2x DDR5 4800 MHz SO-DIMM Socket, Supports Un-buffered and ECC Type, Up to 64GB
BIOS	<ul style="list-style-type: none"> AMI BIOS
Graphics	
Graphics Engine	<ul style="list-style-type: none"> Integrated Intel® UHD Graphics 770: Core™ i9/i7/i5 Integrated Intel® UHD Graphics 730: Core™ i3 Integrated Intel® UHD Graphics 710: Pentium®/Celeron®
Maximum Display Output	<ul style="list-style-type: none"> Supports Quad Independent Display
VGA	<ul style="list-style-type: none"> 1x VGA Connector: 1920 x 1080 @60Hz
DP	<ul style="list-style-type: none"> 2x DP Connector: 4096 x 2304@60Hz * Verified maximum DP resolution: 3840x2160 @60Hz
HDMI	<ul style="list-style-type: none"> 1x HDMI Connector: 4096x2160@30Hz * Verified maximum resolution: 3840x2160 @30Hz
Audio	
Audio Codec	<ul style="list-style-type: none"> Realtek® ALC888, High Definition Audio
Line-out	<ul style="list-style-type: none"> 1x Line-out, Phone Jack 3.5mm
Mic-in	<ul style="list-style-type: none"> 1x Mic-in, Phone Jack 3.5mm
I/O	
LAN	<ul style="list-style-type: none"> 2x GbE LAN, RJ45 <ul style="list-style-type: none"> - GbE1: Intel® I219 - GbE2: Intel® I210
COM	<ul style="list-style-type: none"> 2x RS-232/422/485 with Auto Flow Control (Supports 5V/12V), DB9

USB	<ul style="list-style-type: none"> • 2x 10Gbps USB 3.2 Gen2, Type A • 4x 5Gbps USB 3.2 Gen1, Type A • 2x 480Mbps USB 2.0, Type A
PS/2	<ul style="list-style-type: none"> • 1x PS/2, 6 Pin Mini-DIN Female Connector
Storage	
SSD/HDD	<ul style="list-style-type: none"> • 1x 2.5" Front Accessible SATA HDD/SSD Bay (SATA3.0) • 1x 2.5" Internal SATA HDD/SSD Bay (SATA3.0)
mSATA	<ul style="list-style-type: none"> • 3x mSATA Socket (SATA 3.0, shared by Mini-PCIe socket)
M.2 SSD	<ul style="list-style-type: none"> • 1x M.2 Key M Type 2280 Socket, Support PCIe GEN3 x4 NVMe SSD or SATA SSD (SATA3.0)
RAID	<ul style="list-style-type: none"> • Support RAID 0/1/5/10
Expansion	
PCI Express	<ul style="list-style-type: none"> • 1 x PCI/PCIe Expansion Slot with Optional Riser Card (DS-1401) • 2x PCI/PCIe Expansion Slot with Optional Riser Card (DS-1402) * Supports maximum dimensions of add-on card (H x L):111 x 235mm
Mini PCI Express	<ul style="list-style-type: none"> • 3x Full-size Mini-PCIe Socket
SIM Socket	<ul style="list-style-type: none"> • 2x SIM Socket
CMI (Combined Multiple I/O) Interface	<ul style="list-style-type: none"> • 2x High Speed CMI Interface for optional CMI Module Expansion • 2x Low Speed CMI Interface for optional CMI Module Expansion
CFM (Control Function Module) Interface	<ul style="list-style-type: none"> • 1x CFM IGN Interface for optional CFM-IGN Module Expansion
Other Function	
External FAN Connector	<ul style="list-style-type: none"> • 1x External FAN Connector, 4-pin Terminal Block (Support Smart Fan by BIOS)
Power Ignition Sensing	<ul style="list-style-type: none"> • Support Power Ignition Sensing Function with Delay Time Management and Selectable 12V/24V (With Optional CFM Module)
Clear CMOS Switch	<ul style="list-style-type: none"> • 1x Clear CMOS Switch
Reset Button	<ul style="list-style-type: none"> • 1x Reset Button
Instant Reboot	<ul style="list-style-type: none"> • Support 0.2sec Instant Reboot Technology
Watchdog Timer	<ul style="list-style-type: none"> • Software Programmable Supports 256 Levels System Reset
Power	
Power Button	<ul style="list-style-type: none"> • 1x ATX Power On/Off Button
Power Mode Switch	<ul style="list-style-type: none"> • 1x AT/ATX Mode Switch
Power Input	<ul style="list-style-type: none"> • 9 - 48VDC, 3-pin Terminal Block
Remote Power On/Off	<ul style="list-style-type: none"> • 1x Remote Power On/Off, 2-pin Terminal Block
Remote Power LED	<ul style="list-style-type: none"> • 1x Remote Power LED, 2-pin Terminal Block
Physical	
Dimension (W x D x H)	<ul style="list-style-type: none"> • 227 x 261 x 88 mm (DS-1400)

	<ul style="list-style-type: none"> • 227 x 261 x 108 mm (DS-1401) • 227 x 261 x 128 mm (DS-1402)
Weight Information	<ul style="list-style-type: none"> • 4.5 KG (DS-1400) • 5.02 KG (DS-1401) • 5.44 KG (DS-1402)
Mechanical Construction	<ul style="list-style-type: none"> • Extruded Aluminum with Heavy Duty Metal
Mounting	<ul style="list-style-type: none"> • Wall Mount
Physical Design	<ul style="list-style-type: none"> • Fanless Design • Cableless Design • Jumper-less Design • Unibody Design
Reliability & Protection	
Reverse Power Input Protection	<ul style="list-style-type: none"> • Yes
Over Voltage Protection	<ul style="list-style-type: none"> • Protection Range: 51-58V • Protection Type: shut down operating voltage, re-power on at the present level to recover
Over Current Protection	<ul style="list-style-type: none"> • 15A
CMOS Battery Backup	<ul style="list-style-type: none"> • SuperCap Integrated for CMOS Battery Maintenance-free Operation
MTBF	<ul style="list-style-type: none"> • 371,274 Hours - Database: Telcordia SR-332 Issue3, Method 1, Case 3
Environment	
Operating Temperature	<ul style="list-style-type: none"> • 35W TDP Processor: -40°C to 70°C • 65W TDP Processor: -40°C to 50°C (With External Fan Kit) - With extended temperature peripherals; Ambient with air flow - According to IEC60068-2-1, IEC60068-2-2, IEC60068-2-14
Storage Temperature	<ul style="list-style-type: none"> • -40°C to 85°C
Relative Humidity	<ul style="list-style-type: none"> • 95%RH @ 70°C (non-Condensing)
Shock	<ul style="list-style-type: none"> • MIL-STD-810G
Vibration	<ul style="list-style-type: none"> • MIL-STD-810G
EMC	<ul style="list-style-type: none"> • CE, UKCA, FCC, ICES-003 Class A • EN 50155 (EN 50121-3-2 Only)
Safety	<ul style="list-style-type: none"> • UL, cUL, CB, IEC, EN 62368-1
Operating System	
Windows	<ul style="list-style-type: none"> • Windows® 10
Linux	<ul style="list-style-type: none"> • Supports by project

** Product Specifications and features are for reference only and are subject to change without prior notice. For more information, please refer to the latest product datasheet from Cincoze's website.*

1.3 External Layout

1.3.1 Front

DS-1400

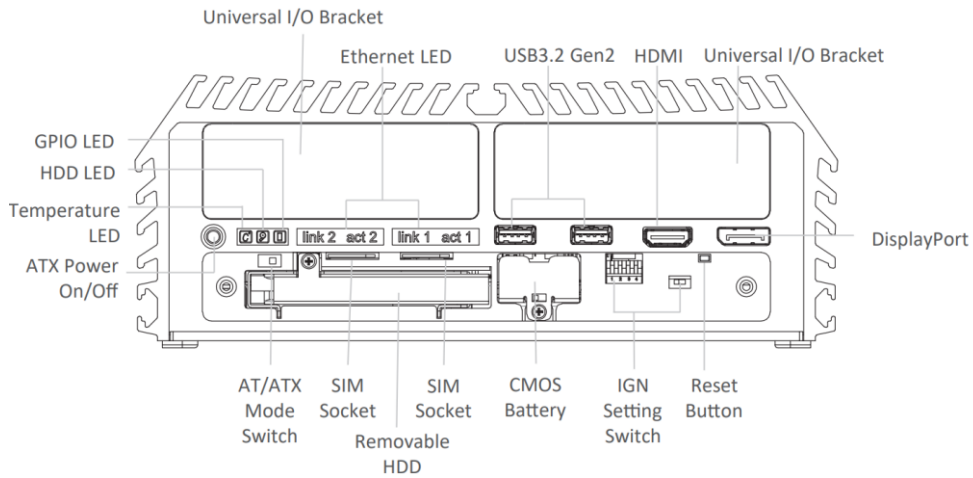

DS-1401

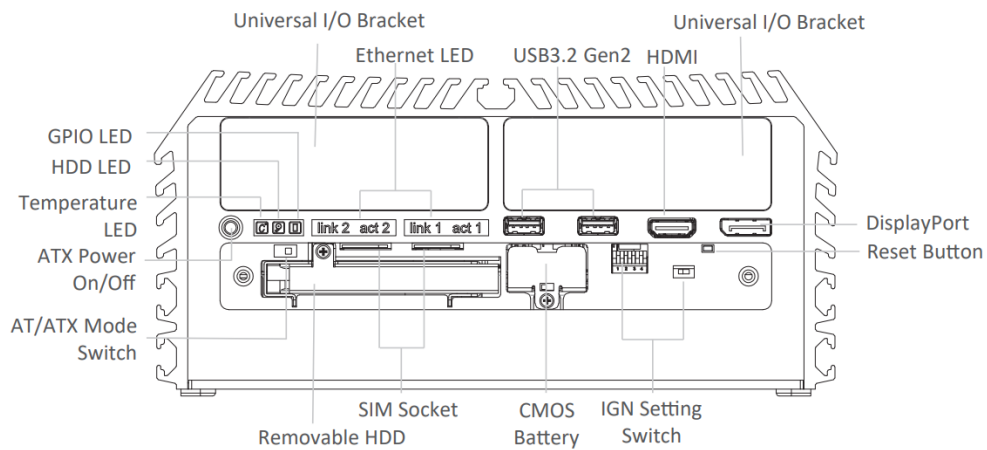

DS-1402

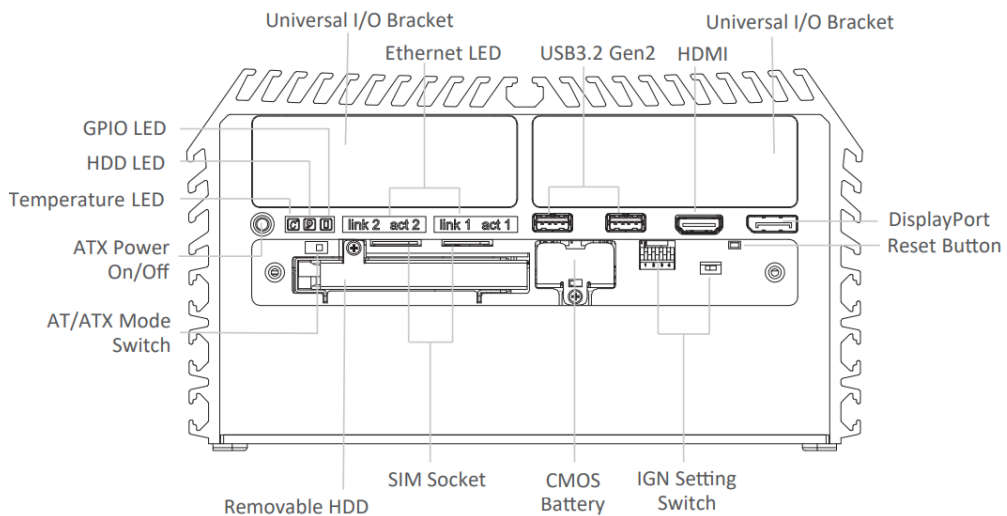

1.3.2 Rear DS-1400

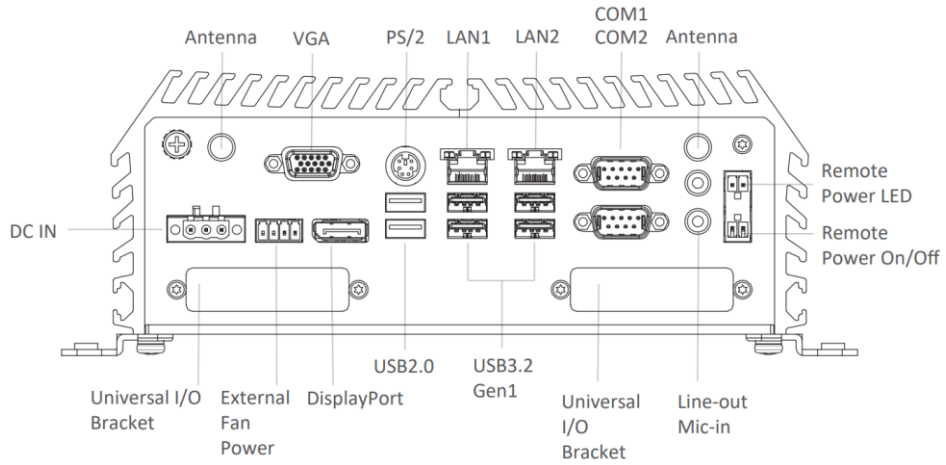

DS-1401

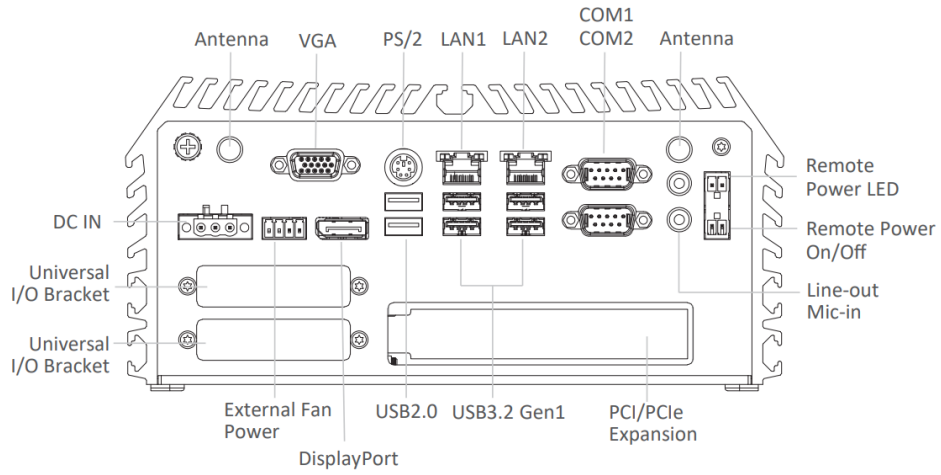

DS-1402

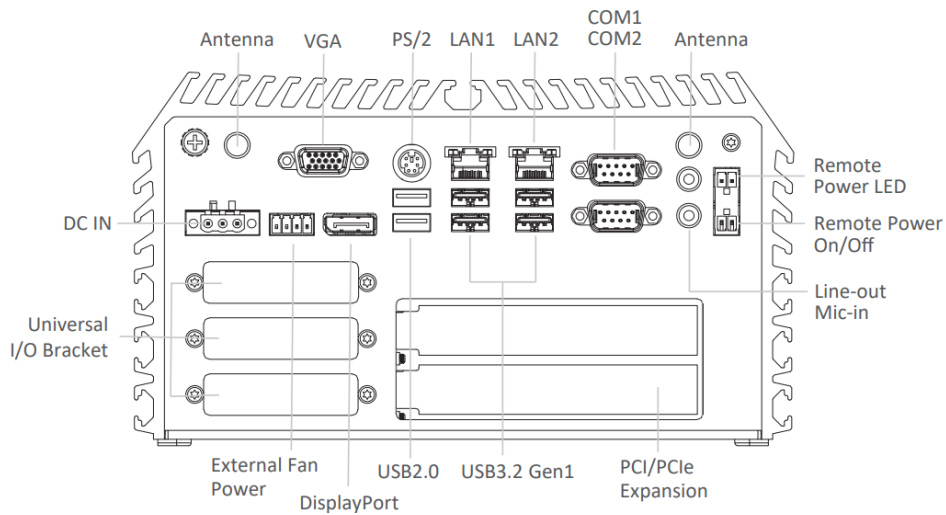

1.4 Dimensions

DS-1400

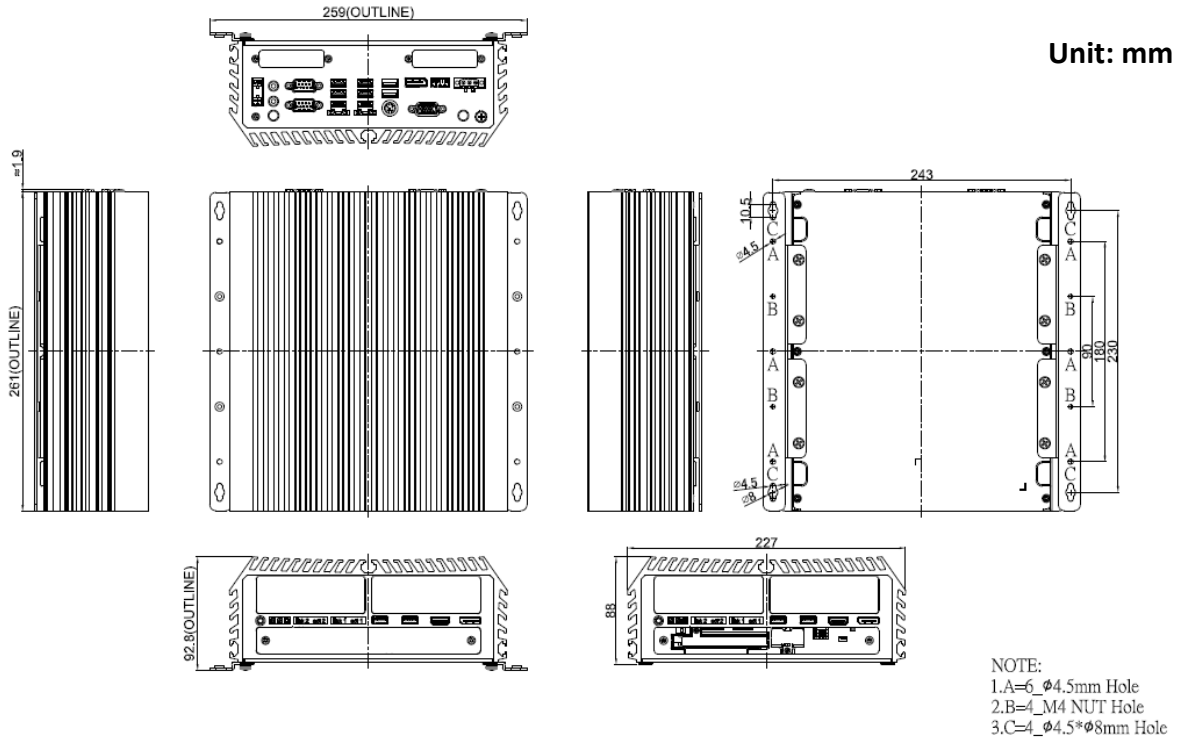

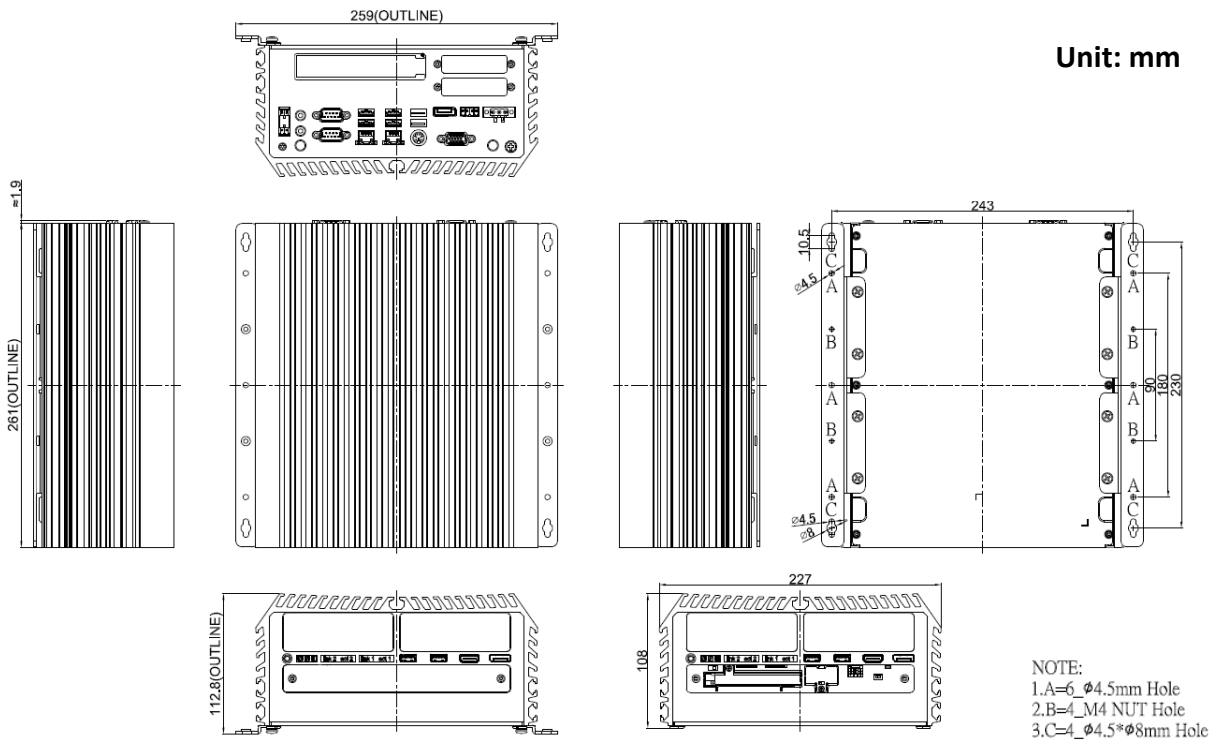

DS-1401

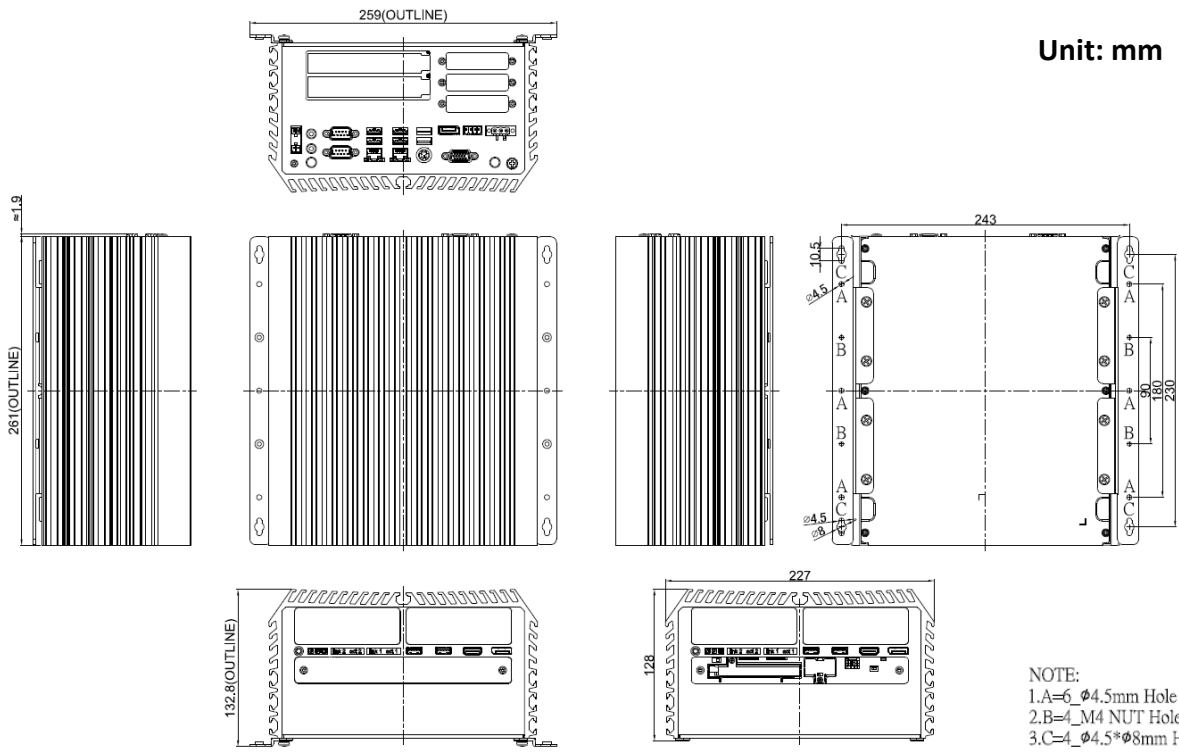

DS-1402





Chapter 2

Introduction to Switches and Connectors

2.1 Location of Switches and Connectors

2.1.1 Top View

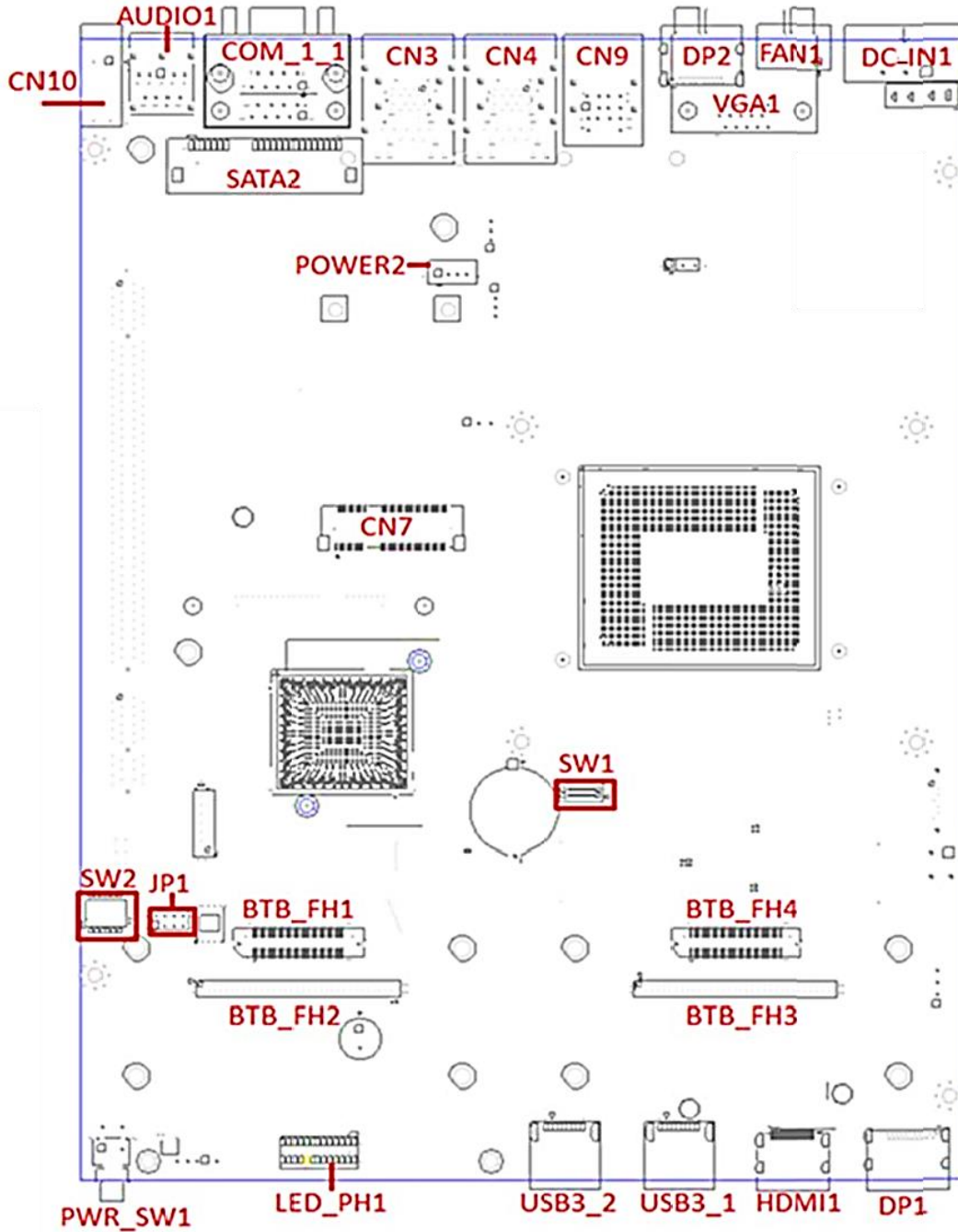

2.1.2 Bottom View

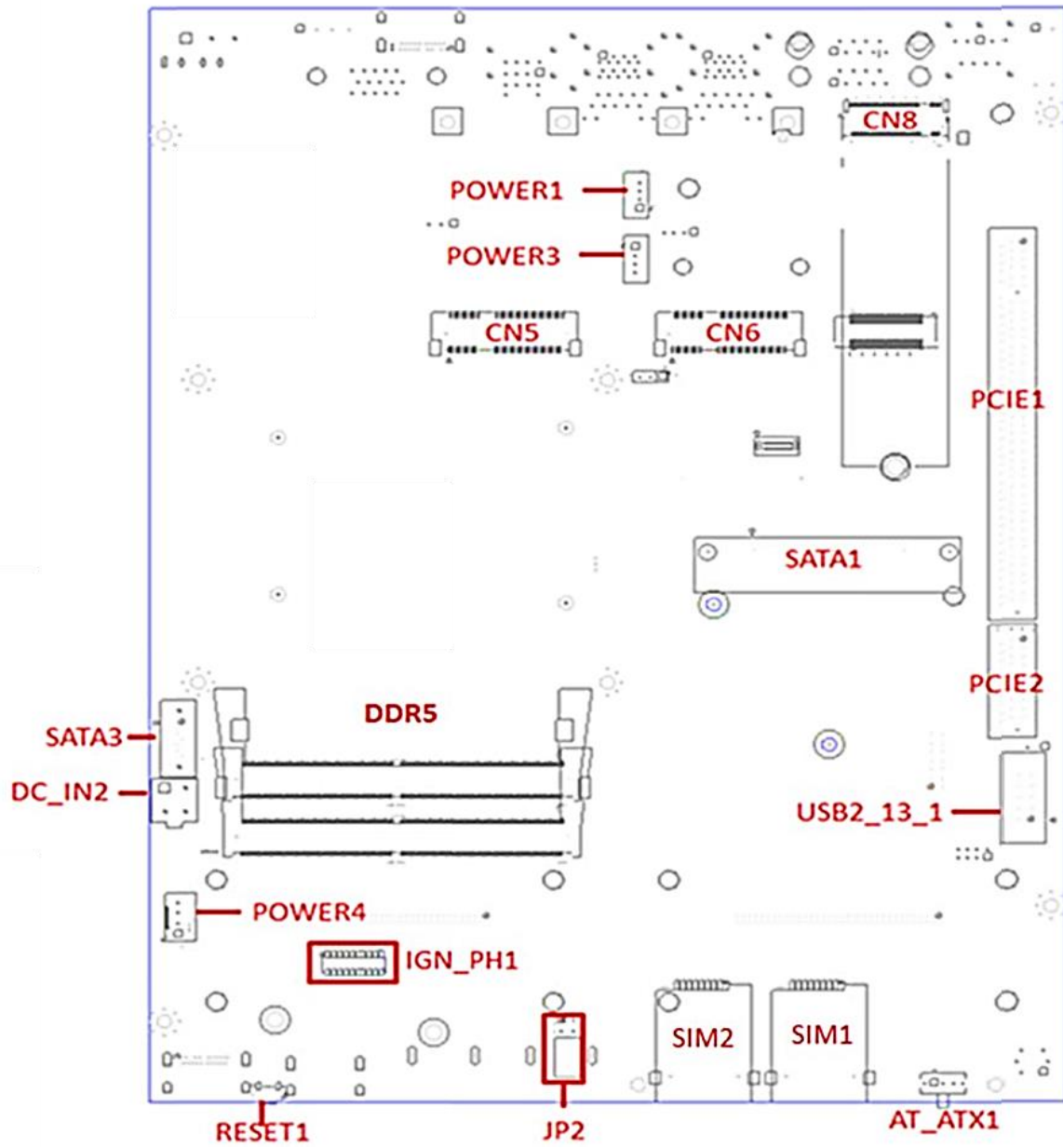

2.2 Switches and Connectors Definition

List of Switch & Connector

Connector	Definition
DC_IN1	3-pin DC 9~48V Power Input with Power Ignition Connector
DP1, DP2	DisplayPort Connector
VGA1	VGA Connector
HDMI1	HDMI Connector
FAN1	External PWM Fan Connector
CN9	PS/2 and USB2.0 Ports
CN4	LAN2 and USB3.0 Ports
CN3	LAN1 and USB3.0 Ports
COM_1_1	COM1 /COM2, RS232 / RS422 / RS485 Connector
AUDIO1	Audio Jack / MIC_IN / LINE_OUT
CN10	Remote Power on / off & LED.
SATA1,2	22 Pin SATA Connector
SATA3	7 Pin SATA Connector
Power 1~4	5V 12V Power Connector
CN5, CN6	Mini PCI-Express Socket (Support mPCIe/ mSATA)
CN7	Mini PCI-Express Socket (Support mPCIe/ mSATA / USB3 + 4G module)
SW1	Super CAP/ Engineering use
SW2	SATA DOM / COM1 / COM2 Power Select
BTB_FH1, BTB_FH4	PSE LAN Port Board to Board Connector
BTB_FH2, BTB_FH3	DIO or COM Port Board to Board Connector
USB3_1, USB3_2	USB 3.1 Gen2 Ports
PWR_SW1	Power button with power on LED
LED_PH1	IGN Temperature, HDD, GPIO, LAN2 LED, LAN1 LED
CN8	M.2 Key M Socket (Support AHCI or NVMe PCIe / SATA Storage)
PCIE1	PCI-Express X16 Socket
PCIE2	PCI-Express X1 Socket /FAN
USB2_13_1	Internal USB 2.0 Ports
DDR5	DDR5 SODIMM Socket
IGN_PH1	IGN Board to Board connector
SIM1, SIM2	SIM Card Socket

AT_ATX1	AT / ATX Power Mode Switch
RESET	Reset button
PWR_SW1	Power Switch
DC_IN2	4-Pin DC Out
JP1	BIOS SPI interface (Optional)
JP2	RTC Battery board to board connector

2.3 Definition of Switches

PWR_SW1: Power button with power on LED

Switch	Definition
Push	Power System



LED Type	LED Status	Status
Power LED	Blue	Power off (S4/S5)
	Green	Power on (S0)
	Blinking Blue & Green	Stand by (S3)

SW1: Super CAP Switch

Location	Function	DIP1	DIP2
SW1	Super CAP	Enabled	ON (Default)
		Disabled	OFF
			ON (Default)



ON
OFF

SW2: SATA DOM / COM1 / COM2 Power Select

Location	Function	DIP1	DIP2
SW2	SATA DOM	Disable	ON (Default)
		Enable	OFF
Location	Function	DIP3	DIP4
SW2	COM1	0V(RI)	ON (Default)
		5V	ON
		12V	OFF
Location	Function	DIP5	DIP6
SW2	COM2	0V(RI)	ON (Default)
		5V	ON
		12V	OFF

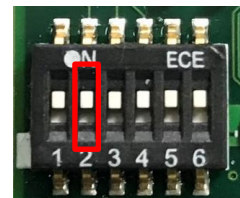

ON
OFF

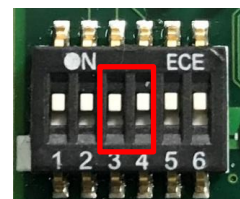

ON
OFF

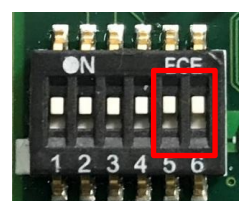

ON
OFF

RESET1: Reset Button

Switch	Definition
Push	Reset System



AT_ATX: AT / ATX Power Mode Switch

Switch	Definition
Left	AT Power Mode
Right	ATX Power Mode (Default)



JP2: Clear BIOS Switch

Pin	Definition
1-2 (Left)	Normal Status (Default)
2-3 (Right)	Clear BIOS



2.4 Definition of Connectors

CN5 : Mini PCI-Express Socket (Support mPCIe/ mSATA)

PIN	Definition	PIN	Definition
1	WAKE#	27	GND
2	3.3V	28	+1.5V
3	NA	29	GND
4	GND	30	SMB_CLK
5	NA	31	PETN/SATATN
6	1.5V	32	SMB_DATA
7	CLKREQ#	33	PETP/SATATP
8	NA	34	GND
9	GND	35	GND
10	NA	36	USB_D-
11	REFCLK-	37	GND
12	NA	38	USB_D+
13	REFCLK+	39	3.3V
14	NA	40	GND
15	GND	41	3.3V
16	NA	42	NA
17	NA	43	GND
18	GND	44	NA
19	NA	45	NA
20	3.3V	46	NA
21	GND	47	NA
22	PERST#	48	+1.5V
23	PERN/SATARP	49	NA
24	+3.3VAUX	50	GND
25	PERP/SATARN	51	NA
26	GND	52	+3.3V

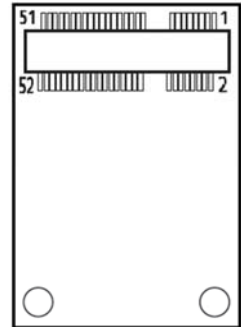

CN6 : Mini PCI-Express Socket (Support mPCIE/ mSATA)

PIN	Definition	PIN	Definition
1	WAKE#	27	GND
2	3.3V	28	+1.5V
3	NA	29	GND
4	GND	30	SMB_CLK
5	NA	31	PETN/SATATXN
6	1.5V	32	SMB_DATA
7	NA	33	PETP/SATATXP
8	NA	34	GND
9	GND	35	GND
10	NA	36	USB_D-
11	NA	37	GND
12	NA	38	USB_D+
13	NA	39	3.3V
14	NA	40	GND
15	GND	41	3.3V
16	NA	42	NA
17	NA	43	GND
18	GND	44	NA
19	NA	45	NA
20	3.3V	46	NA
21	GND	47	NA
22	PERST#	48	+1.5V
23	PERN/SATARXP	49	NA
24	3.3V	50	GND
25	PERPSATARXN	51	NA
26	GND	52	+3.3V

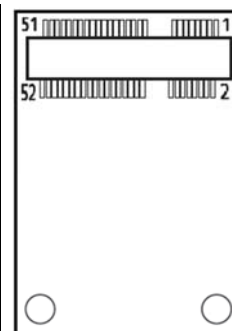

CN7 : Mini PCI-Express Socket (Support mPCIE/ mSATA / USB3 + 4G module)

PIN	Definition	PIN	Definition
1	WAKE#	27	GND
2	3.3V	28	+1.5V
3	NA	29	GND
4	GND	30	SMB_CLK
5	NA	31	PETN/SATATN/USB3TN
6	1.5V	32	SMB_DATA
7	UIM_RST2	33	PETP/SATAP/USB3TP
8	SIM_PWR1	34	GND
9	GND	35	GND
10	SIM_DATA1	36	USB_D-
11	REFCLK-	37	RESERVED
12	SIM_CLK	38	USB_D+
13	REFCLK+/SIM_PWR2	39	RESERVED
14	SIM_Reset1	40	GND
15	GND	41	3.3V
16	SIM_VPP1	42	NA
17	SIM_CLK2	43	GND
18	GND	44	NA
19	SIM_DATA2	45	NA
20	3.3V	46	NA
21	GND	47	NA
22	PERST#	48	+1.5V
23	PERN/SATARP/USB3RN	49	NA
24	3.3V	50	GND
25	PERP/SATARN/USB3RP	51	NA
26	GND	52	+3.3V

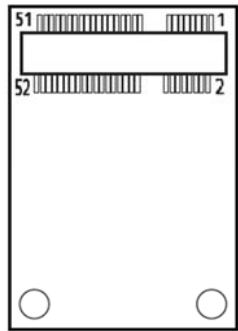

CN8 : M.2 Key M 2280 Socket (Support AHCI or NVMe PCIe / SATA Storage)

(Pin 59-66 are connector keys)

Pin	Definition	Pin	Definition	Pin	Definition
1	CFG3	27	GND	53	REFCLKN
2	+3.3V	28	NC	54	PEWAKE#
3	GND	29	PERN1	55	REFCLKP
4	+3.3V	30	NC	56	NC
5	PERN3	31	PERP1	57	GND
6	NC	32	NC	58	NC
7	PERP3	33	GND	59	key
8	NC	34	NC	60	key
9	GND	35	PETN1	61	key
10	LED	36	NC	62	key
11	PETN3	37	PETP1	63	key
12	+3.3V	38	DEVSLP	64	key
13	PETP3	39	GND	65	key
14	+3.3V	40	SMB_CLK	66	key
15	GND	41	PERNO/SATARPO	67	NC
16	+3.3V	42	SMD_DATA	68	SUSCLK
17	PERN2	43	PERPO/SATARNO	69	PEDET
18	+3.3V	44	ALERT#	70	+3.3V
19	PERP2	45	GND	71	GND
20	NC	46	NC	72	+3.3V
21	CFG0	47	PETNO/SATATNO	73	GND
22	NC	48	NC	74	+3.3V
23	PETN2	49	PETPO/SATATPO	75	CFG2
24	NC	50	RESET#	76	NC
25	PETP2	51	GND		
26	NC	52	NC		

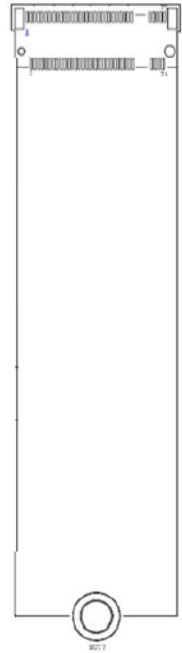

POWER1, POWER2, POWER3: +5V/+12V Power Output Connector

Connector Type: 1X4-pin Wafer, 2.0 mm pitch

Pin	Definition
1	+5V
2	GND
3	GND
4	+12V

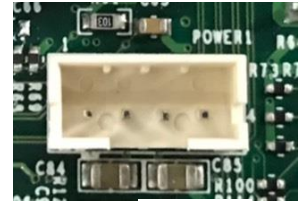

1 2 3 4

POWER4: Power Connector

Connector Type: 1X4-pin Wafer, 2.54mm pitch

Pin	Definition
1	+5V
2	GND
3	GND
4	+12V



1 2 3 4

CN10 : Remote Power On/Off + Remote Power LED Connector

Remote Power LED connector can connect an external LED indicator up to 10mA.

Connector Type: Terminal Block 2X2 4-pin, 3.5mm pitch

Pin	Definition
1	PWR_SW
2	LED
3	GND
4	GND

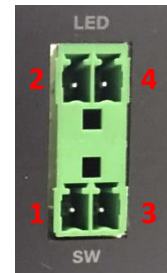

WARNING
(AVERTIR)

Do not apply power to this connector! This port is used to connect a SWITCH!

(Ne mettez pas sous tension ce connecteur! Ce port est utilisé pour connecter un SWITCH!)

FAN1: CPU Smart Fan Connector

Connector Type: Terminal Block 1X4 4-pin, 3.5mm pitch

Pin	Definition
1	GND
2	+12V
3	SENSE
4	Control

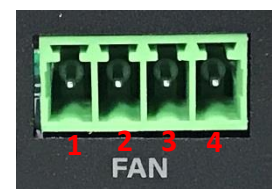

SATA3: 7 PINs SATA/SATA DOM Connector

Pin	Definition	Pin	Definition
1	GND	5	B-
2	A+	6	B+
3	A-	7	+5V
4	GND		



USB2_13_1: USB2.0 BOX Header (2 Ports)

Connector Type: Box Header, 2x5 10-pin, 2.54mm pitch

Pin	Definition	Pin	Definition
1	VBUS (+5V)	6	USB2_P1_DP
2	VBUS (+5V)	7	GND
3	USB2_P0_DN	8	GND
4	USB2_P1_DN	9	CGND
5	USB2_P0_DP	10	CGND

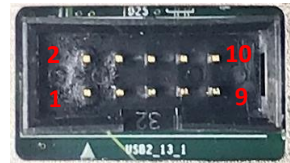

COM1 / COM2 : RS232 / RS422 / RS485 Connector

Connector Type: 9-pin D-Sub

Pin	RS232 Definition	RS422 / 485 Full Duplex Definition	RS485 Half Duplex Definition
1	DCD	TX-	DATA -
2	RXD	TX+	DATA +
3	TXD	RX+	
4	DTR	RX-	
5	GND		
6	DSR		
7	RTS		
8	CTS		
9	RI		



DC_IN1: 3 PINs DC 9-48V power input with power ignition connector

Connector Type: Terminal Block 1x3 3-pin, 5.0mm pitch

Pin	Definition
1	+9-48VIN
2	Ignition (IGN)
3	GND

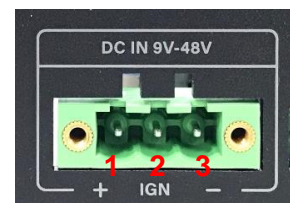

**CAUTION
(ATTENTION)**

Please disconnect the power source before mounting the DC power cables or connecting the DC power connector to system.

(Veuillez débrancher la source d'alimentation avant de monter les câbles d'alimentation CC ou de connecter le connecteur d'alimentation CC au système.)

DC_IN2: 4 PINs DC 9-48V Power Connector

Connector Type: 2x2 4-pin, 4.2mm pitch

Pin	Definition
1	GND
2	GND
3	+9-48VIN
4	+9-48VIN

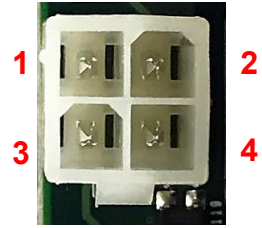

WARNING
(AVERTIR)

Before using this connector, make sure that the PIN3 & PIN4 voltage meets the power requirements of the device.

(Avant d'utiliser ce connecteur, assurez-vous que la tension PIN3 et PIN4 répond aux exigences d'alimentation de l'appareil.)

LED_PH1: LED board connector

LED type	Status	LED Color
TEMP LED	System Temp $\leq 65^{\circ}\text{C}$	Colorless
	$65^{\circ}\text{C} < \text{System Temp} \leq 70^{\circ}\text{C}$	Blue
	$70^{\circ}\text{C} < \text{System Temp} \leq 75^{\circ}\text{C}$	Red
	$75^{\circ}\text{C} < \text{System Temp}$	Blinking Red
HDD LED	Data activity	Yellow
	No activity	Off
GPIO LED	GPIO activity	Green
	No activity	Off

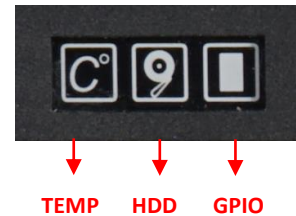

NOTE
(NOTE)

The TEMP LED is only available when IGN module is installed.

(La LED TEMP n'est disponible que lorsque le module IGN est installé.)

LAN LED Status Definition

Link LED Status	Definition
Steady Green	1 Gbps Network Link
Steady Orange	100 Mbps Network Link
Off	10 Mbps Network Link
Act LED Status	Definition
Blinking Yellow	Data Activity
Steady Yellow	No Activity

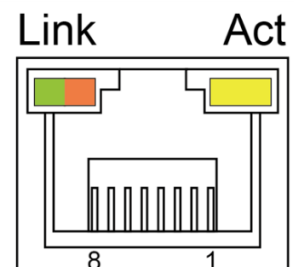

2.5 Optional Module Pin Definition & Settings

2.5.1 CMI-M12LAN01-R12/UB1010 Module

CMI-M12 LAN Module Pin Definitions

Connector Type: M12 A coded 8pin connector

Pin	Definition	Pin	Definition
1	2_LAN1_0+	2	2_LAN1_0-
3	2_LAN1_1+	4	2_LAN1_2+
5	2_LAN1_2-	6	2_LAN1_1-
7	2_LAN1_3+	8	2_LAN1_3-

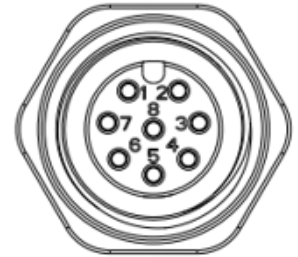

2.5.2 CMI-XM12LAN01-R12/UB1030 Module

CMI-XM12LAN01 Module Pin Definitions

Connector Type: M12 X coded 8pin connector

Pin	Definition	Pin	Definition
1	D1+	2	D1-
3	D2+	4	D2-
5	D4+	6	D4-
7	D3-	8	D3+

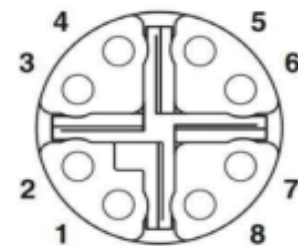

2.5.3 CMI-DIO02/UB1018 Module



DIO1: Digital Input / Output Connector

Connector Type: Terminal Block 2X5 10-pin, 3.5mm pitch

Pin	Definition	Pin	Definition
1	DI1	11	DO1
2	DI2	12	DO2
3	DI3	13	DO3
4	DI4	14	DO4
5	XCOM+ (DC INPUT)	15	XCOM- (GND)

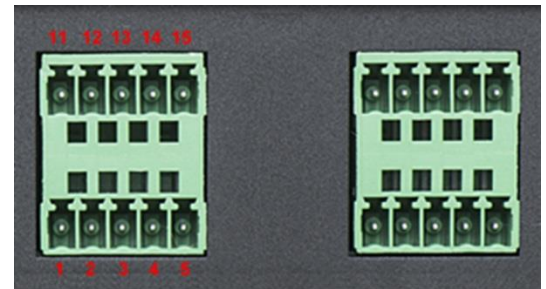

Pin	Definition	Pin	Definition
6	DI5	16	DO5
7	DI6	17	DO6
8	DI7	18	DO7
9	DI8	19	DO8
10	2XCOM+ (DC INPUT)	20	2XCOM- (GND)

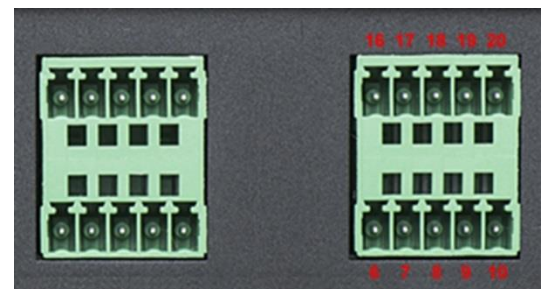

2.5.4 CMI-COM02/UB1004 Module

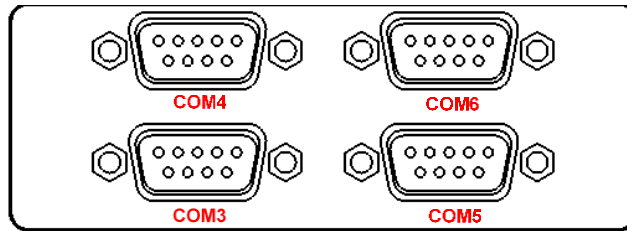

COM3~COM6 : RS232 / RS422 / RS485 Connector

Connector Type: 9-pin D-Sub

Pin	RS232 Definition	RS422 / 485 Full Duplex Definition	RS485 Half Duplex Definition
1	DCD	TX-	DATA -
2	RXD	TX+	DATA +
3	TXD	RX+	
4	DTR	RX-	
5	GND		
6	DSR		
7	RTS		
8	CTS		
9	RI		



SW1 on CMI-COM02 Module : COM3~COM6 Power Select

Location	Function	DIP1	DIP2
SW1	COM3	0V(RI)	ON (Default)
		5V	ON
		12V	OFF
SW1	COM4	0V(RI)	ON (Default)
		5V	ON
		12V	OFF
SW1	COM5	0V(RI)	ON (Default)
		5V	ON
		12V	OFF
SW1	COM6	0V(RI)	ON (Default)
		5V	ON
		12V	OFF

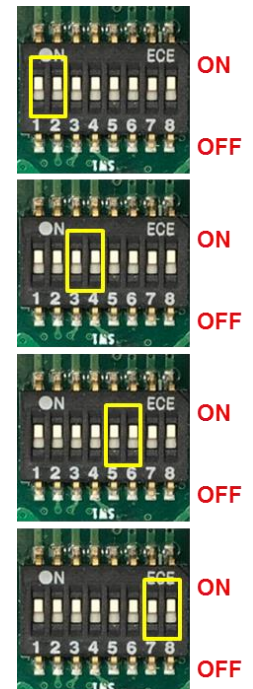

2.5.5 CMI-ICOM01/UB1004 Module

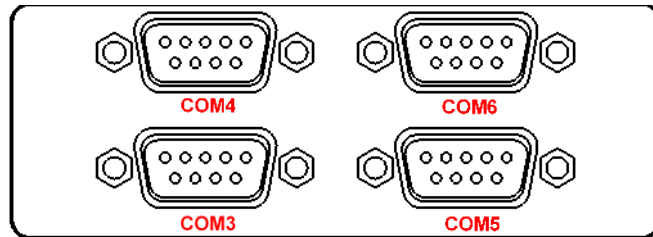

COM3~COM6 : RS232 Connector

Connector Type: 9-pin D-Sub

Pin	RS232 Definition
1	DCD
2	RXD
3	TXD
4	DTR
5	GND
6	DSR
7	RTS
8	CTS
9	RI



**NOTE
(NOTE)**

**COM3/4/5/6 are isolated COM, each pin5 (GND) is independent.
(COM3/4/5/6 sont des COM isolés, chaque pin5 (GND) est indépendant.)**

2.5.6 CFM-IGN101 Module

SW2 : IGN Module Timing Setting Switch

Set shutdown delay timer when ACC is turned off

Pin 1	Pin 2	Pin 3	Pin 4	Definition
ON (IGN Enabled)	ON	ON	ON	0 second
	ON	ON	OFF	1 minute
	ON	OFF	ON	5 minutes
	ON	OFF	OFF	10 minutes
/	OFF	ON	ON	30 minutes
	OFF	ON	OFF	1 hour
	OFF	OFF	ON	2 hours
	OFF	OFF	OFF	Reserved (0 second)
OFF (IGN Disabled)				

Default setting of Pin1 to Pin4 is OFF / OFF / OFF / OFF.

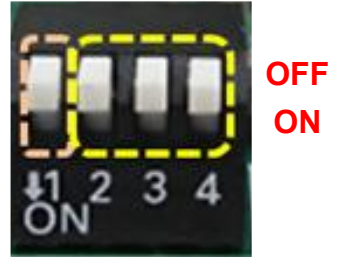

24V_12V_1 : IGN Module Voltage Mode Setting Switch

12V / 24V Car Battery Switch

Switch	Definition
Left	12V Car Battery Input
Right	24V Car Battery Input (Default)





Chapter 3

System Setup

3.1 Removing Top Cover



WARNING
(AVERTIR)

In order to prevent electric shock or system damage, must turn off power and disconnect the unit from power source before removing the chassis cover.

(Afin d'éviter tout risque d'électrocution ou d'endommagement du système, vous devez couper l'alimentation et débrancher l'appareil de la source d'alimentation avant de retirer le couvercle du châssis.)

All the steps in Chapter 3 are demonstrated using the DS-1402 as an example.

Step 1. Turn over the unit to have the bottom side face up, loosen the 6 screws on the bottom cover and place them aside for later use.

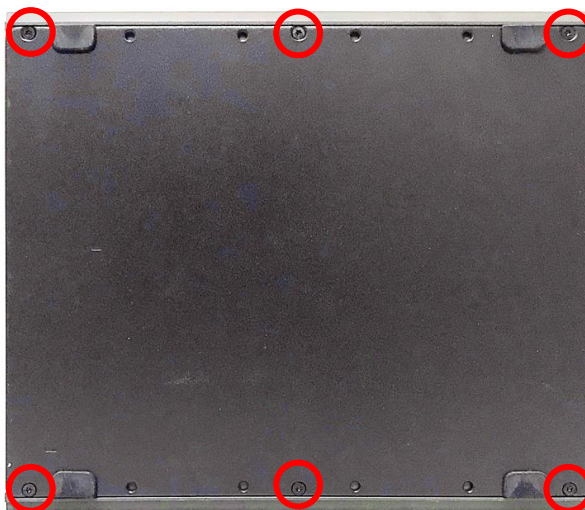

Step 2. Remove the bottom cover from the chassis.



Step 3. Unscrew the 2 screws at the rear bezel as indicated and place them aside for later use.



Step 4. Loosen the 4 screws. Pull out the 4 latches as marked.

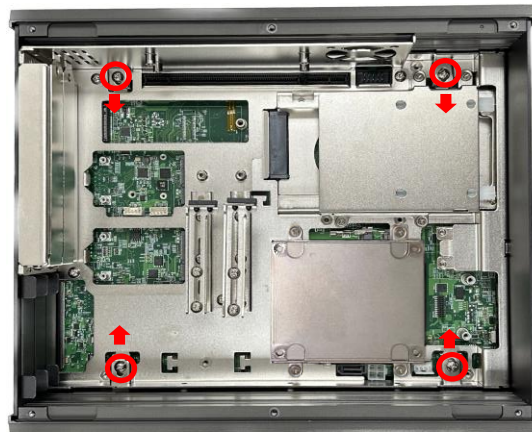

Step 5. Lift up the unit vertically by holding the front and rear panel.



Step 6. Turn over the body of the unit and place it gently.



3.2 Installing CPU

Step 1. Locate the CPU socket.

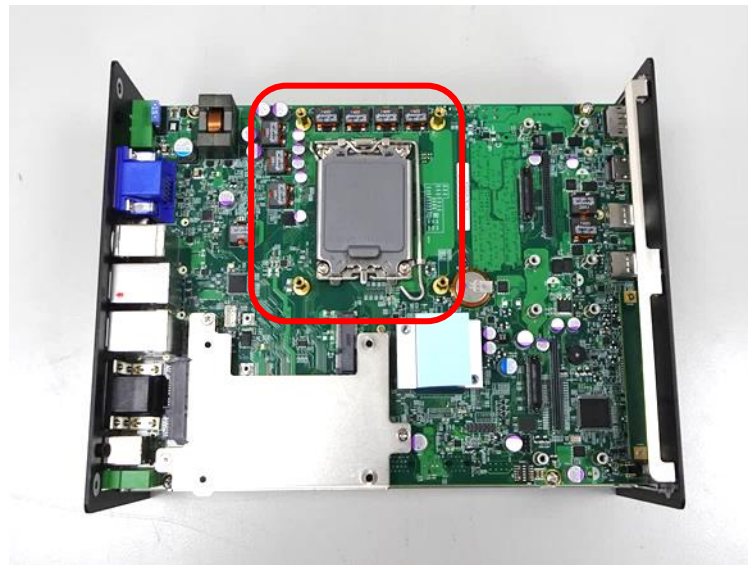

Step 2. Pull up the lever.

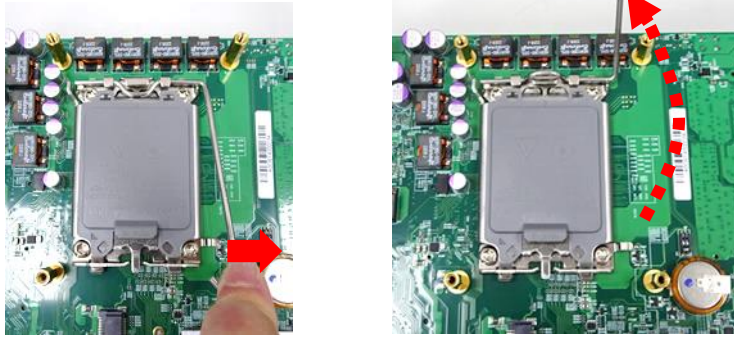

Step 3. Lift up the holder.



Step 4. Align the CPU with the fool-proof protrusions on the socket and put on the CPU.



Step 5. Press down the holder, the cover will be automatically removed, and then place the cover aside.

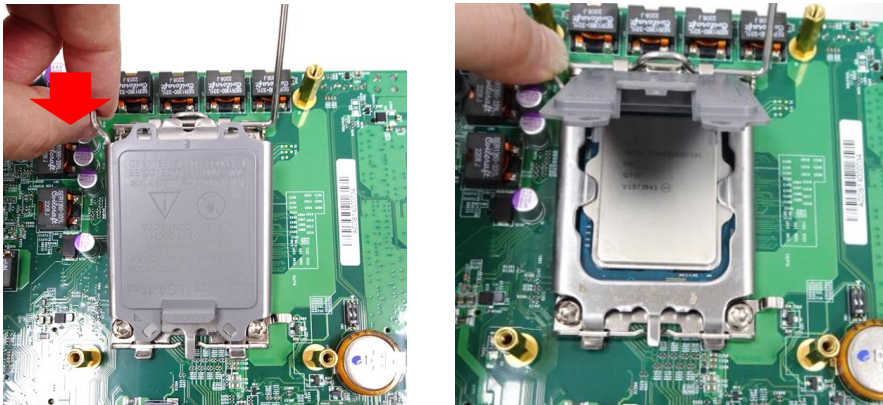

Step 6. Press the lever back to its original place to lock the CPU.



Step 7. Make sure that the CPU is clean, and apply the thermal paste onto the center of the CPU's surface as shown below. For more information about the thermal paste application, please find the [Intel official website](#).



Step 8. Place the CPU heatsink on with aligning the four mounting holes of the heatsink and the nut studs and then fasten the heatsink with the provided 4 screws.

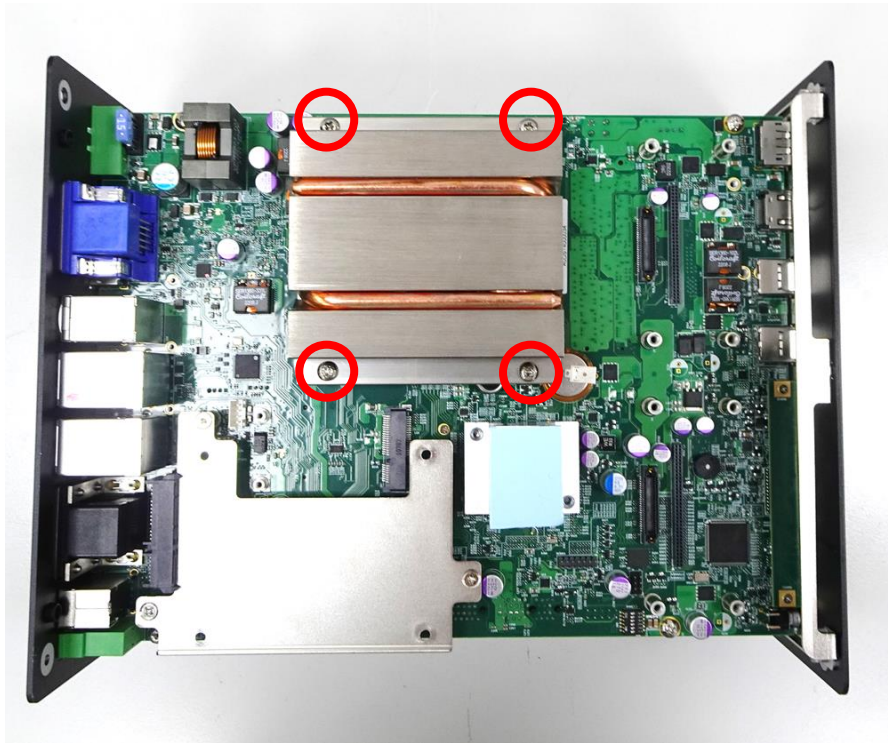

3.3 Installing SO-DIMM

Step 1. Turn the system to the bottom side. Unscrews the 4 screws and remove the bracket.

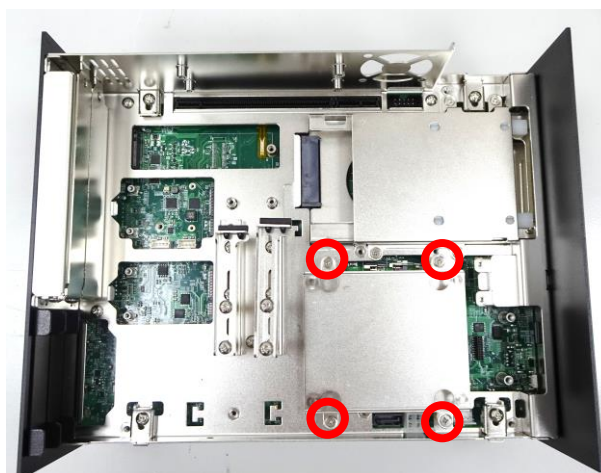

Step 2. Locate two SO-DIMM sockets at the bottom.

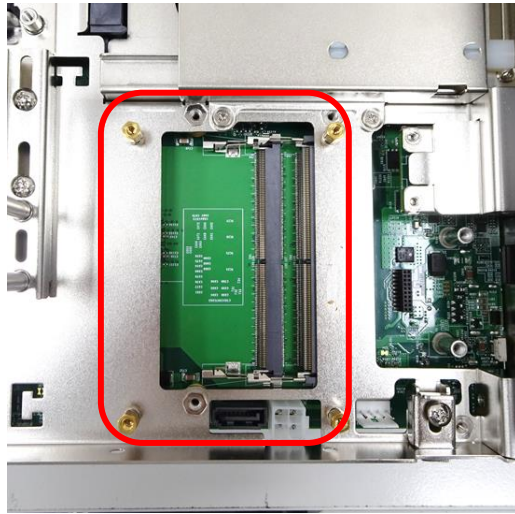

Step 3. Insert the SO-DIMM at a 45-degree angle until its edge connector is connected to the SO-DIMM socket firmly.

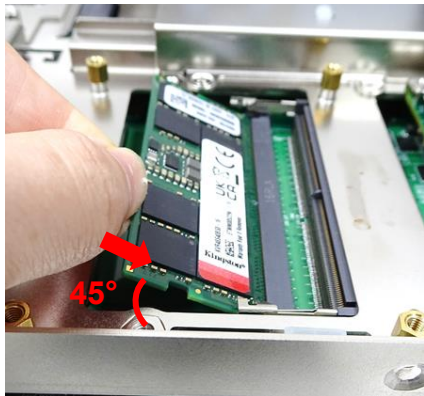

Lower socket

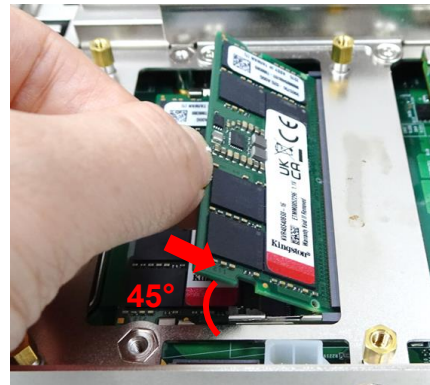

Upper socket

Step 4. Press down the module until the retaining clips snap back in place.



Lower socket



Upper socket

Step 5. Put the cover back and fix the cover with 4 screws.

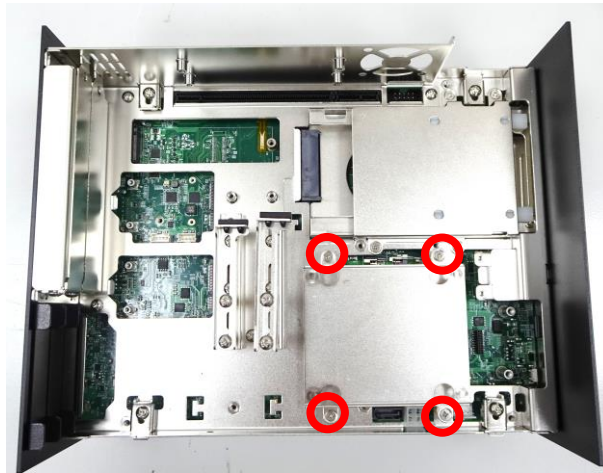

3.4 Installing Mini-PCle Card

Step 1. Locate the Mini PCIe socket CN7 on the top side and CN5/CN6 on the bottom side of the system.

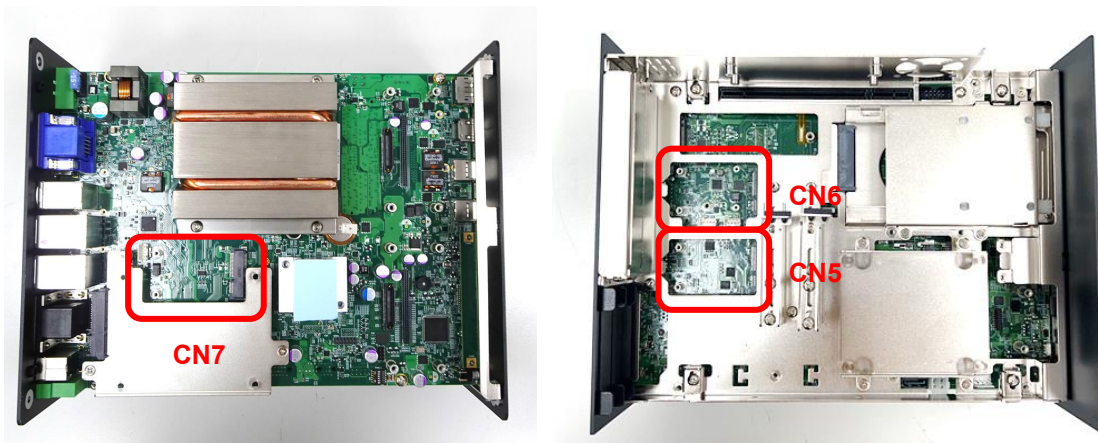

Step 2. Use provided two screws fasten the half size module and adapter bracket together as shown in Fig (a) below.



(a) Half Size Mini-PCle Card

(b) Full Size Mini-PCle Card

Step 3. Tilt a Mini PCIe card at a 45-degree angle and insert it to the socket until the golden finger connector of the card seated firmly.



Step 4. Press the card down and secure it with 2 screws.



3.5 Installing M.2 M Key Card

Step 1. Turn the system to the bottom side, and locate the M.2 M Key slot (CN8).

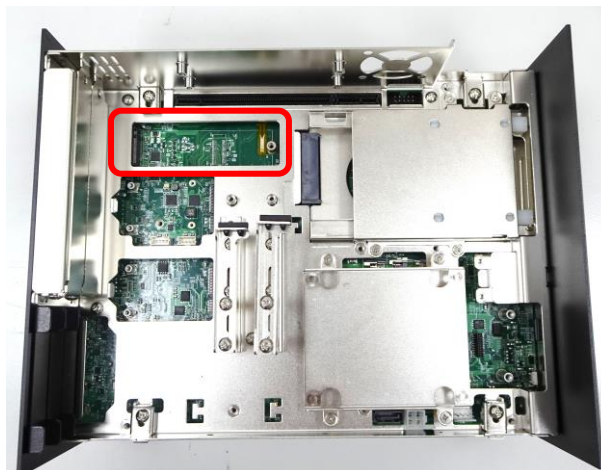

Step 2. Tilt the M.2 M Key card at a 45-degree angle and insert it to the socket until the golden finger connector of the card seated firmly.



Step 3. Press the card down and secure it with the screw.



3.6 Installing Antenna

Step 1. Remove the antenna rubber cover on the rear panel.



Step 2. Penetrate the antenna jack through the hole.



Step 3. Put on the washer and fasten the nut of antenna jack.



Step 4. Assemble the antenna and antenna jack together.



Step 5. Attach the RF connector of the cable's another end onto the card.

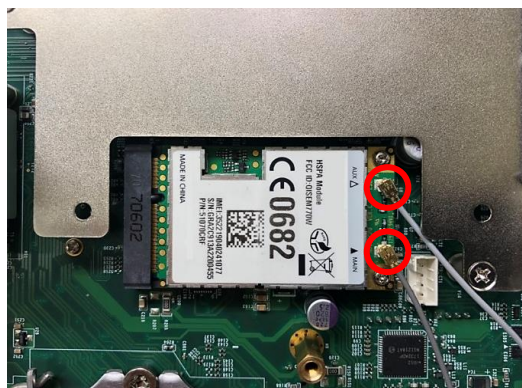

3.7 Installing SATA Hard Drive on Top Side

Step 1. Unscrew the 3 screws on the HDD bracket and remove the bracket.

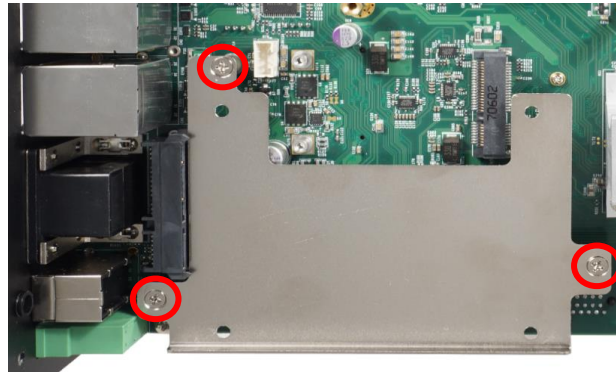

Step 2. Make the PCB side of the HDD face up, and place the HDD bracket on it. Ensure the direction of bracket is correct and use the provided 4 screws to assemble HDD and HDD bracket together.

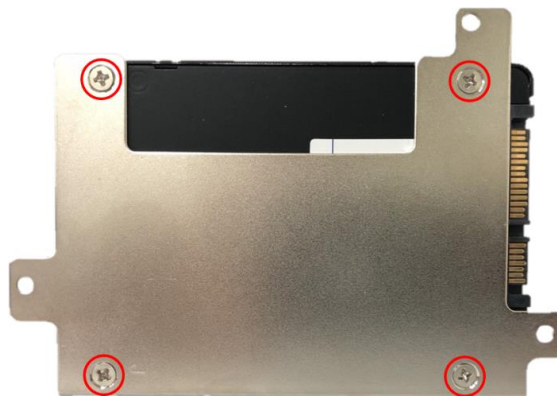

Step 3. Turn over the HDD bracket. Connect the HDD bracket to the SATA connector and fasten the 3 screws.

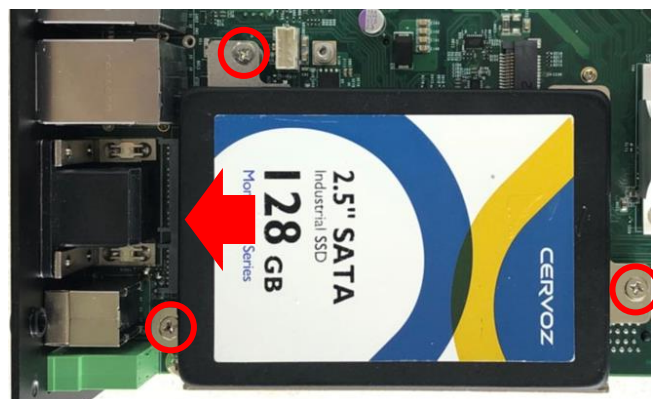

3.8 Installing PCI/PCIe Add-on Card

(For DS-1401 and DS-1402 only)

The applicable riser cards for DS-1400 series are listed in the following table.

Model No.	Description	Compatible Model
RC-E16-01	Riser Card with 1 x PCIe16 Slot	DS-1401
RC-PI-01	Riser Card with 1 x PCI Slot	DS-1401
RC-E8E8-R10	Riser Card with 2 x PCIe8 Slots	DS-1402
RC-E16E1-01	Riser Card with 1 x PCIe16 and 1 x PCIe1 Slots	DS-1402
RC-E16PI-01	Riser Card with 1 x PCIe16 and 1 x PCI Slots	DS-1402
RC-PIPI-01	Riser Card with 2 x PCI Slots	DS-1402



**NOTE
(NOTE)**

The photo example in this section is illustrated by RC-E8E8-R10 module.
(L'exemple de photo dans cette section est illustré par le module RC-E8E8-R10.)

Step 1. Prepare a Riser Card intended for installation.



Riser Card RC-E8E8-R10

Step 2. Unscrew the 4 screws to remove the extension bracket.

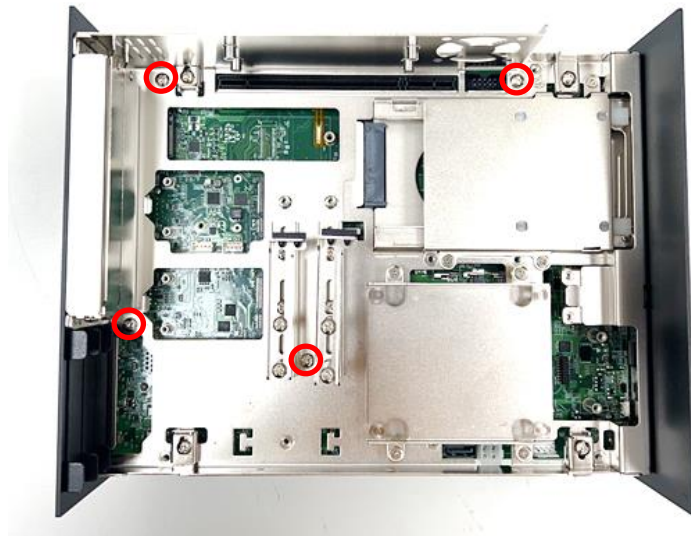

Step 3. Assemble the riser card with extension bracket together and fasten with the 4 screws.

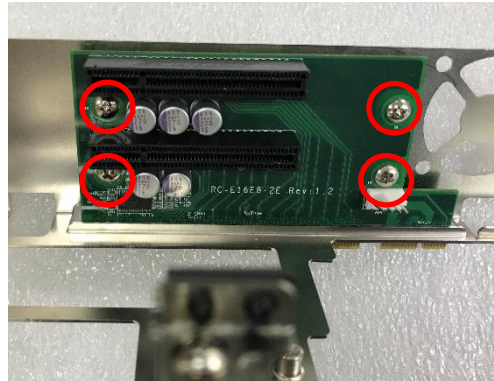
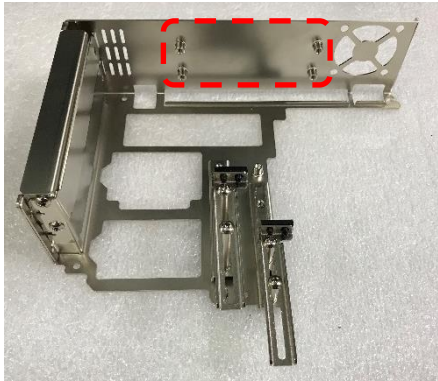

Step 4. (1) Loosen the screw(s) to remove I/O bracket(s). (2) Loosen the screws halfway to allow the card retainer to be adjustable.

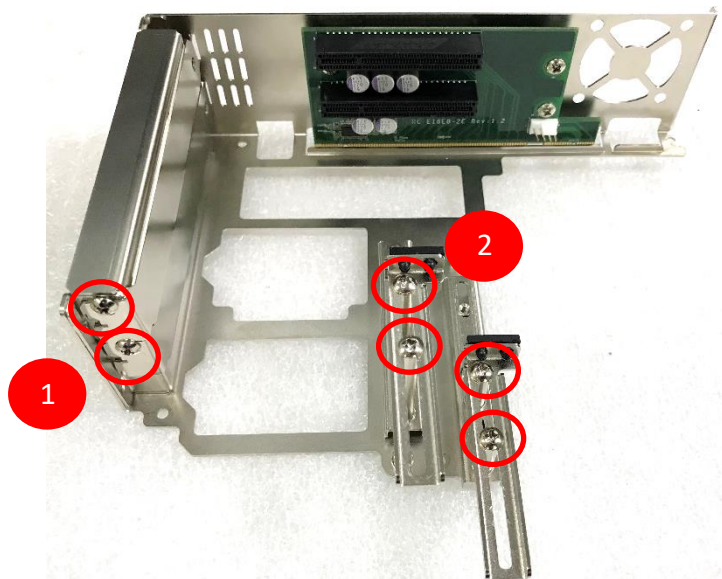

Step 5. (1) Insert PCI(e) add-on card to the slot. (2) Fasten the screw to secure it

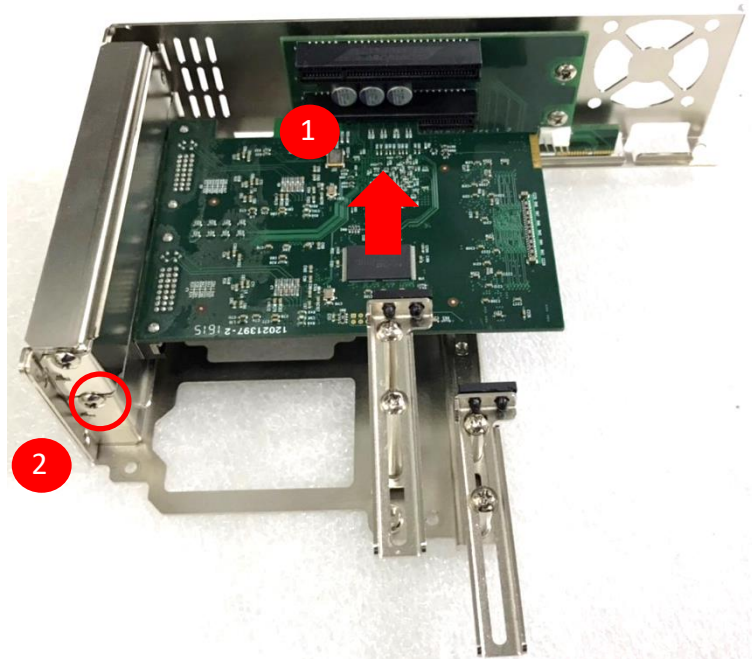

Step 6. (1) Push the card retainer forward to against the edge of the add-on card. (2) Fasten the screws to fix the card retainer.

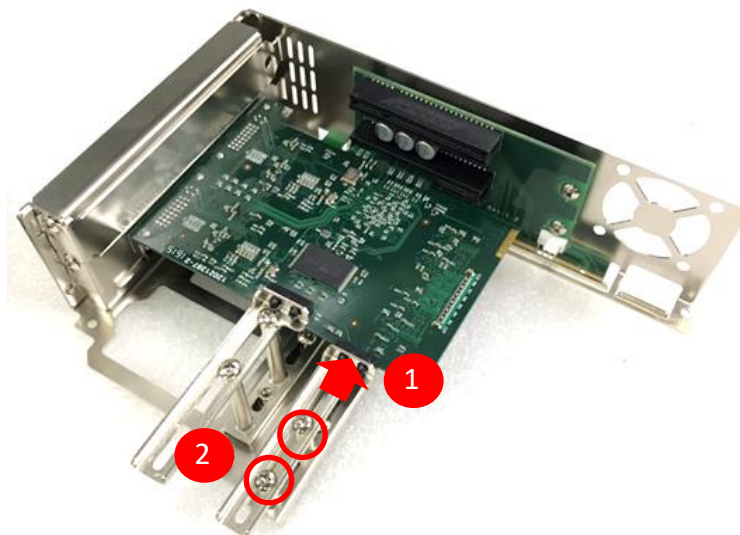

Step 7. Locate the riser card slot on bottom side of system.

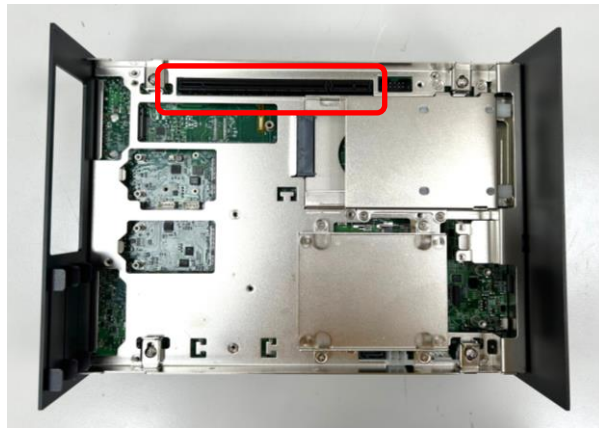

Step 8. Install the module assembled in step 6 into the riser card slot, and fasten the 4 screws to secure it.

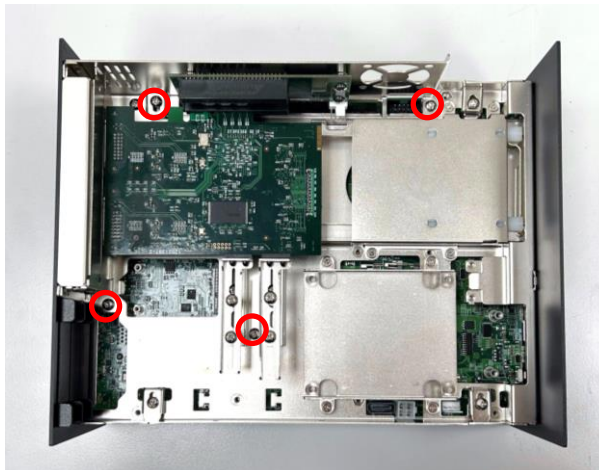

3.9 Assembling Top Cover

Step 1. Make sure the notch on the chassis and the front bezel of the unit body are on the same side.



Step 2. Lift the body of the unit, make sure that the front and rear panels are in the chassis grooves, and then assemble the body into the chassis.



Step 3. Push into the 4 latches as indicated and fasten the 4 screws.

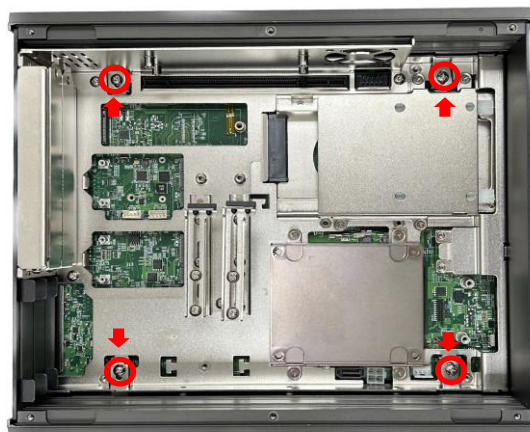

Step 4. Fasten the 2 screws at rear panel.



Step 5. Be sure to align the grooves with front and rear panels. Put the bottom cover back on and fasten the 6 screws to fix the cover.

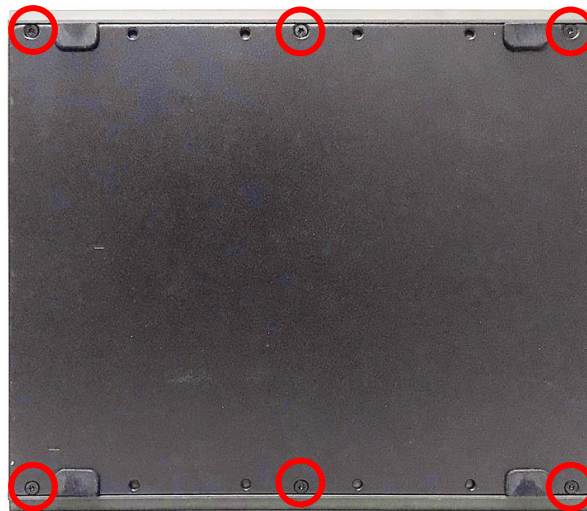

3.10 Installing SATA Hard Drives at Front Panel

Step 1. Loosen the two screws to remove the cover plate of maintenance zone.



Step 2. Loosen the screw to remove the HDD bay cover bracket.



Step 3. Pull the rotating arm and pull the HDD bracket out of system.



Step 4. Make HDD bottom side face up, place the HDD bracket on it. Ensure the direction of bracket is correct and use 4 provided screws to assemble HDD and HDD bracket together.



Step 5. Align the HDD bracket with the entrance of HDD bay. Insert the HDD bracket and push it until the HDD connector is fully inserted into the SATA slot.



Step 6. Place the rotating arm back and fasten the screw.



Step 7. Fix the cover plate of maintenance zone by fastening the two screws.



3.11 Installing SIM Card

Step 1. Loosen the two screws to remove the cover plate of maintenance zone.



Step 2. Locate the SIM card slot at front side and insert a SIM card into a SIM slot with the gold contacts facing up. Please pay attention to the insert orientation as illustrated. (When SIM cards are inserted into both sockets, the network connection will prioritize SIM1.)

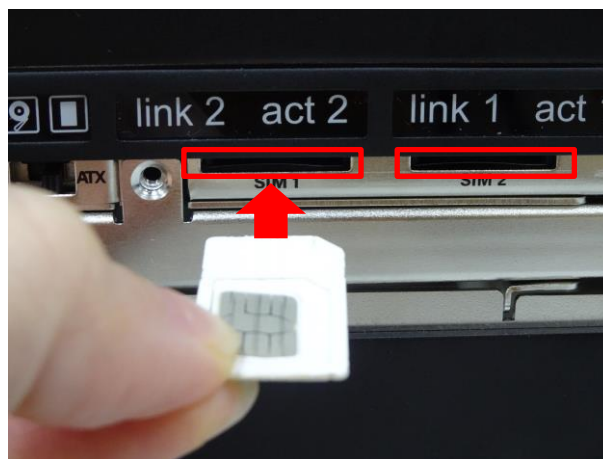

Step 3. Fix the cover plate of maintenance zone by fastening the two screws.



3.12 Replacing CMOS Battery

This chapter is only for the situation that is required to replace the CMOS battery.

Step 1. Loosen the two screws to remove the cover plate of maintenance zone.



Step 2. Locate the removable CMOS Battery and loosen the screw.



Step 3. Pull out the CMOS battery bracket with assistance of a tweezer.



Step 4. Remove the battery by pressing the metal tab backwards slightly as indicated.

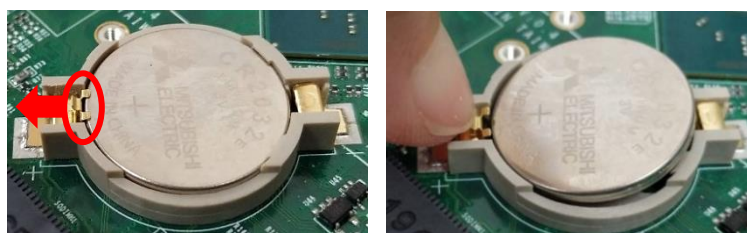

Step 5. Pay attention to the direction of “+” and “-” signs on the battery. Push the battery into the slot from the "-" side and pull the metal tab backwards to make the battery fully installed in the slot.

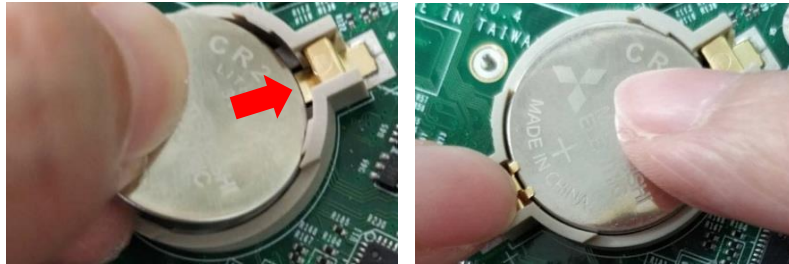

Step 6. Insert the battery bracket firmly.



Step 7. Fasten the screw.



Step 8. Fix the cover plate of maintenance zone by fastening the two screws.



3.13 Installing Wall Mount

DS-1400 series offers wall mount kit that customers can install the system on the wall in a convenient and economical way.



Step 1. The mounting holes are at the bottom side of the system. Use the provided 8 screws to fasten the bracket and the system together.

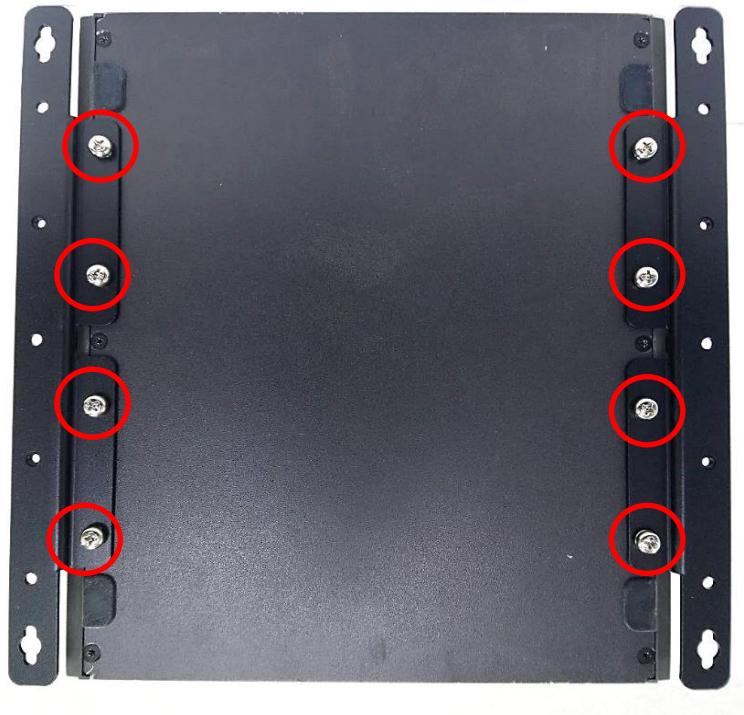

Step 2. Fasten the screws through the bracket mounting holes to mount the system onto the wall.

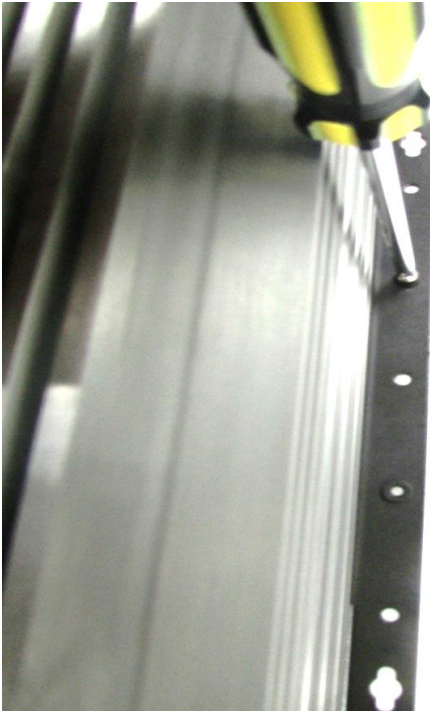

3.14 Connecting to Power Supply

Step 1. Locate the DC_IN1 power connector.



Step 2. Aim the V- wire at the V- port of the connector, and aim the V+ wire at the V+ port of the connector. Then connect the phoenix contacts of the power supply to the DC_IN connector.

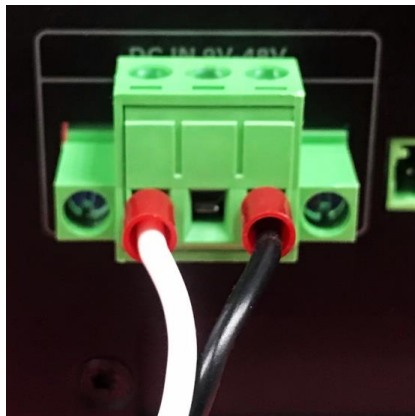

Step 3. Fasten the two screws to fix the phoenix contacts.

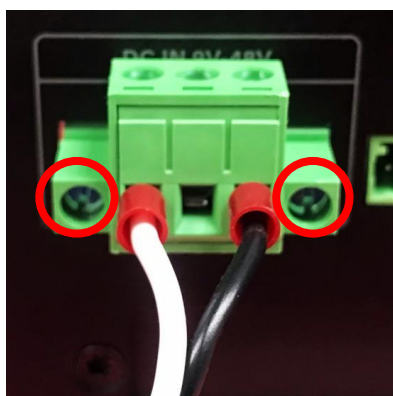

WARNING
(AVERTIR)

In formal use, please use new Phoenix contacts and make sure the screws are tightened to avoid poor connection.

(En utilisation formelle, veuillez utiliser de nouveaux contacts Phoenix et assurez-vous que les vis sont bien serrées pour éviter une mauvaise connexion.)

3.15 Installing CMI Modules

3.15.1 CMI-LAN01-R12/UB1012 Module

Step 1. Loosen the 2 hex nuts from back side of front bezel. Remove the front bezel.

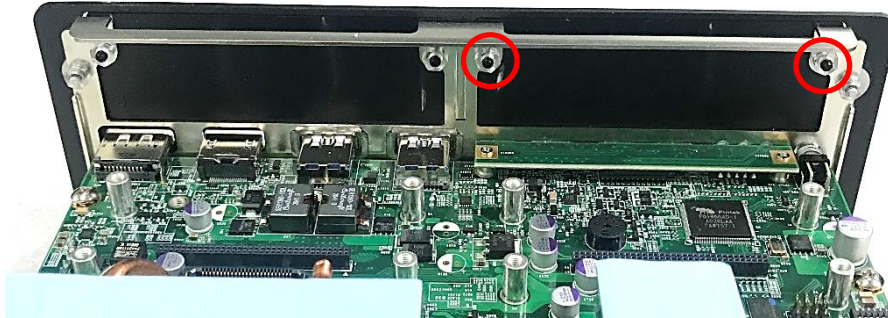

Step 2. Attach the CMI-LAN bracket, and fasten the 2 hex nuts to fix it as indicated.

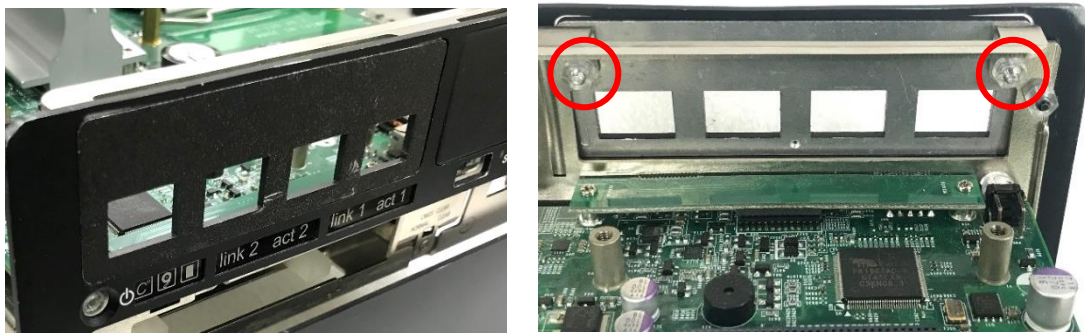

Step 3. Locate the connector(s) of CMI-LAN module on top side of system.

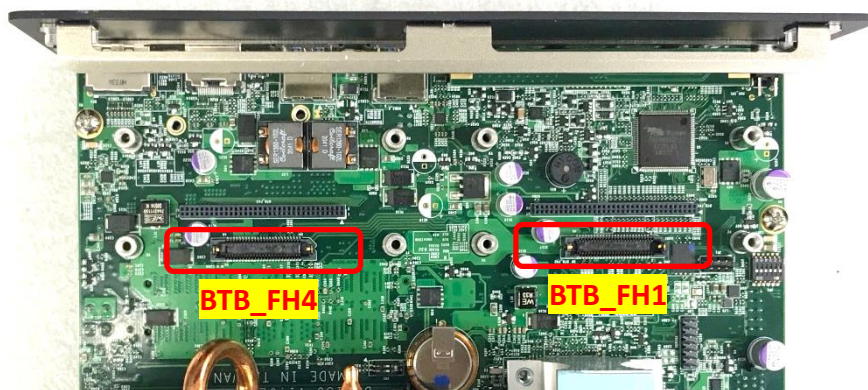

Step 4. Insert the CMI module vertically into the female connector on system's mainboard until it's connected firmly and fasten 4 screws to fix it.

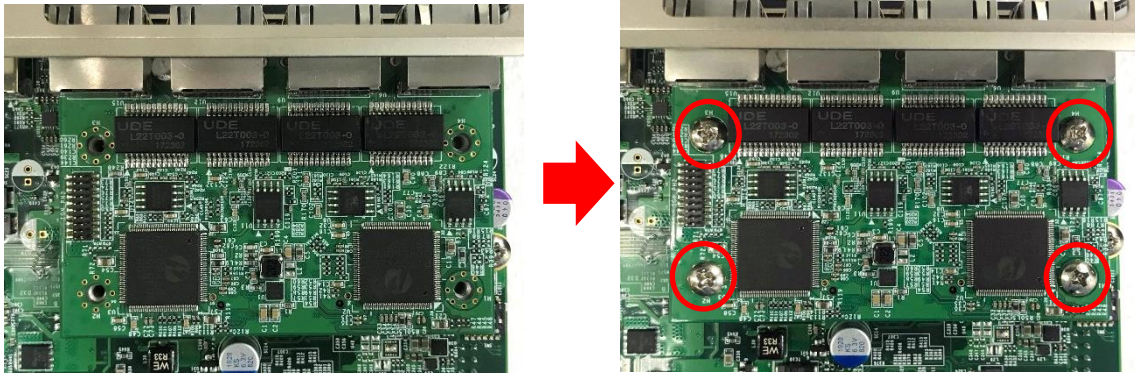

3.15.2 CMI-M12LAN01-R12/UB1010 Module

Step 1. Loosen the 2 hex nuts from back side of front bezel. Remove the front bezel.

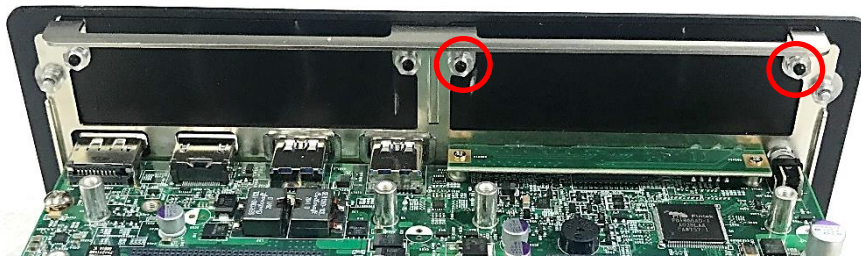

Step 2. Attach the CMI-M12LAN bracket, and fasten the 2 hex nuts to fix it as indicated.

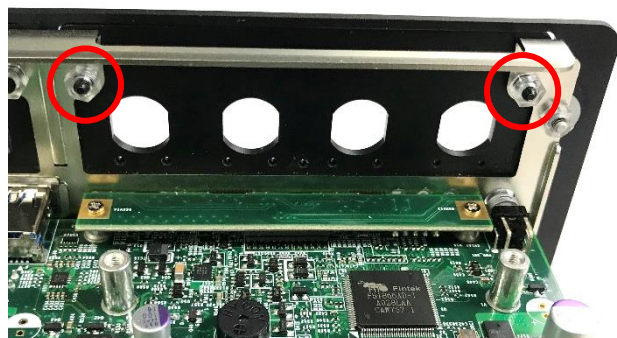

Step 3. Locate the connector(s) of CMI-M12LAN module on top side of system.

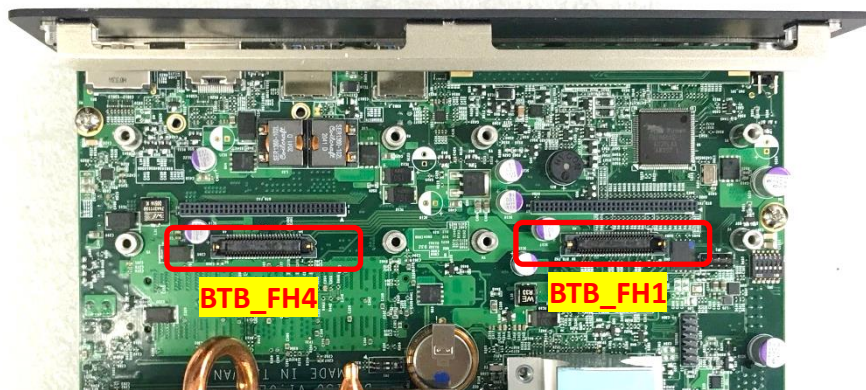

Step 4. Remove the four hex rings from the CMI-M12LAN module.

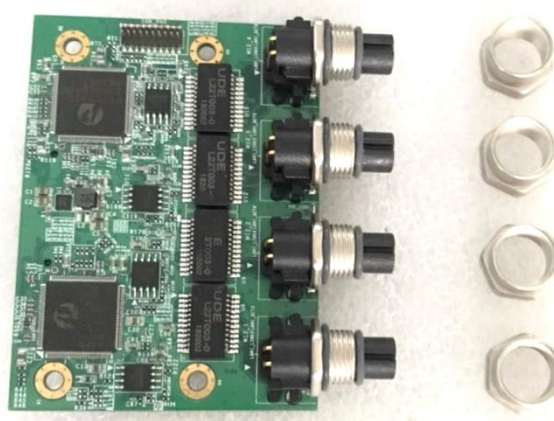

Step 5. Penetrate the CMI-M12LAN ports through the holes on the bracket. Insert the CMI module vertically into the female connector on system's mainboard until it's connected firmly and fasten 4 screws to fix it.

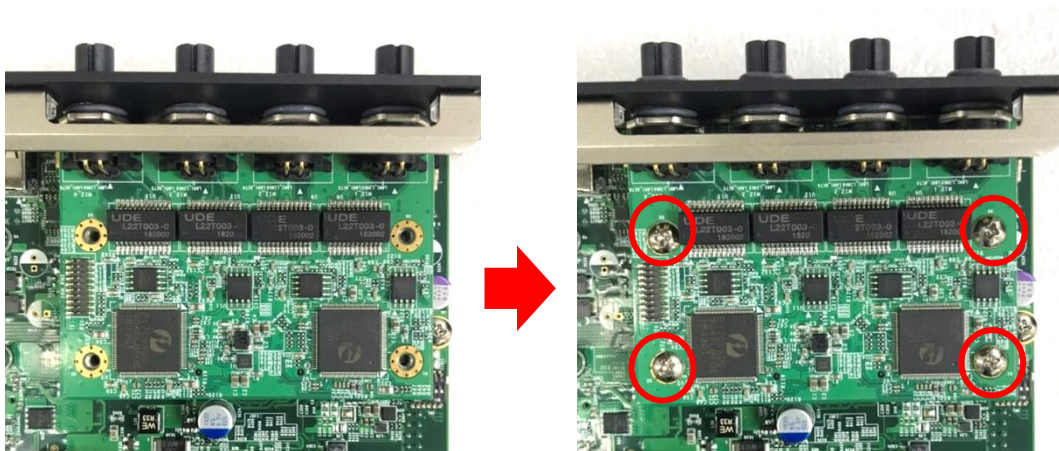

Step 6. Fasten the four hex rings to fix the cover plate.



3.15.3 CMI-XM12LAN01-R10/UB1030 Module

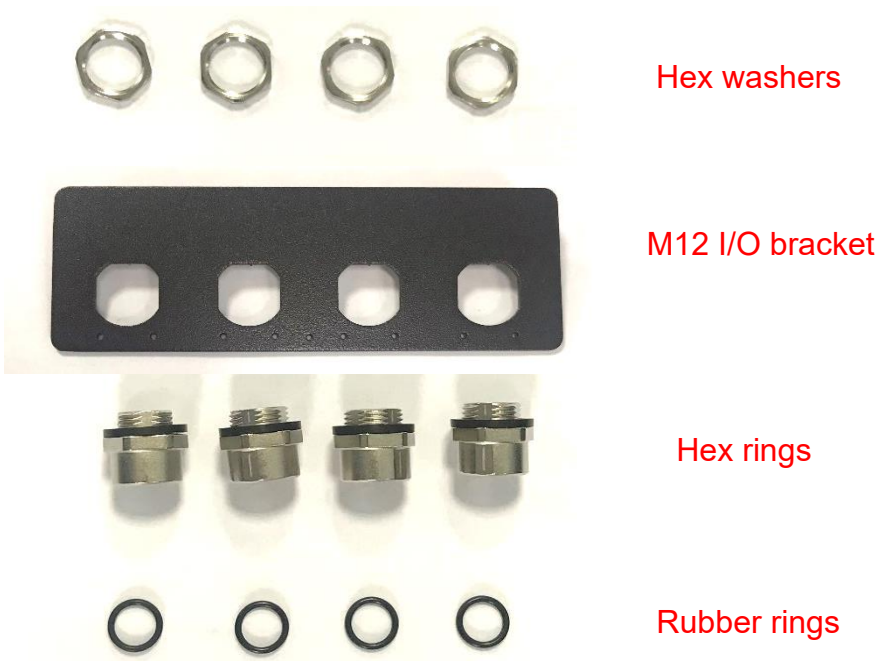

Step 1. Assemble the hex rings, M12 I/O bracket and hex washers together as indicated below: Penetrate hex rings through the M12 I/O bracket holes, and fix them with hex washers.



Step 2. Loosen the 2 hex nuts from back side of front bezel. Remove the front bezel.



Step 3. Locate the connector(s) of CMI-M12LAN module on top side of system.

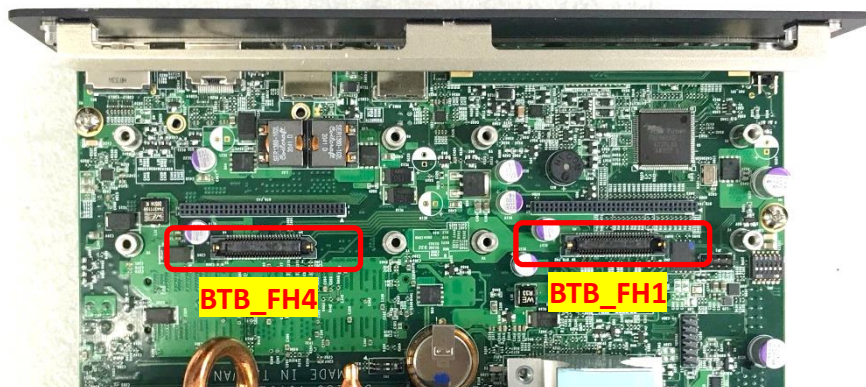

Step 4. Insert the CMI module vertically into the female connector on system's mainboard until it's connected firmly and fasten 4 screws to fix it.

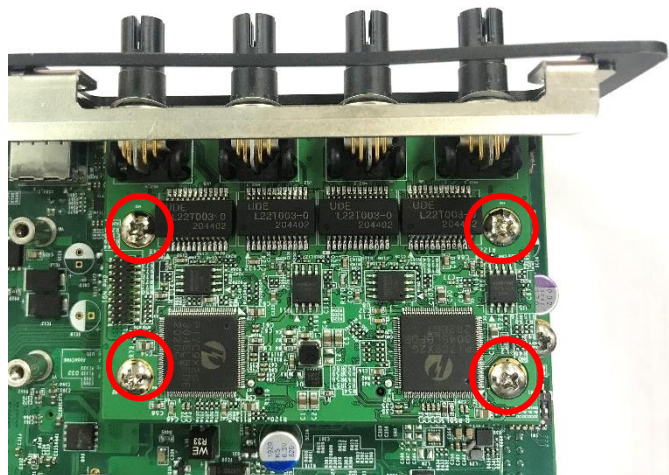

Step 5. Attach the assembled M12 I/O bracket on to the system, and fasten the hex nuts to fix it.

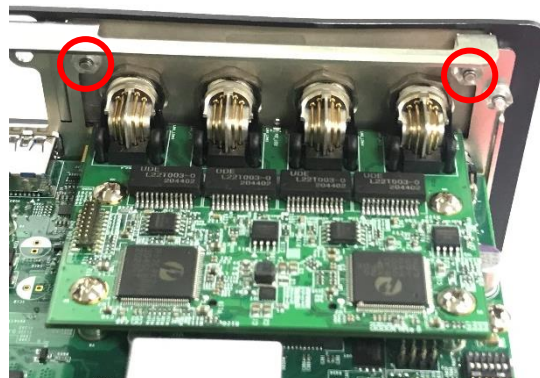

Step 6. Put on the rubber rings to the four M12 LAN ports.

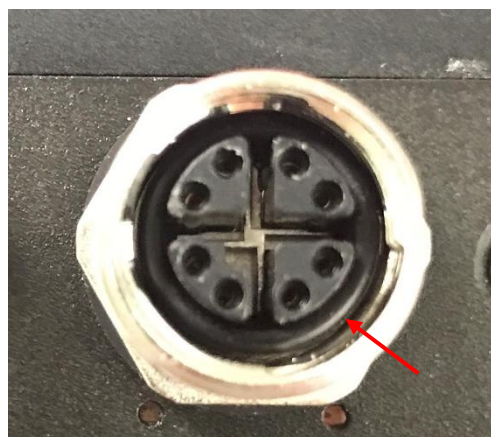

3.15.4 CMI-10GLAN03-R10/UB1028 Module

Before installing this module, users need to enter BIOS to complete the following setting first. When entering BIOS, get to Chipset > PCH-IO Configuration page, and change the [BTB_FH1 Mode Selection] setting from default mode [4x1] to mode [1x4].

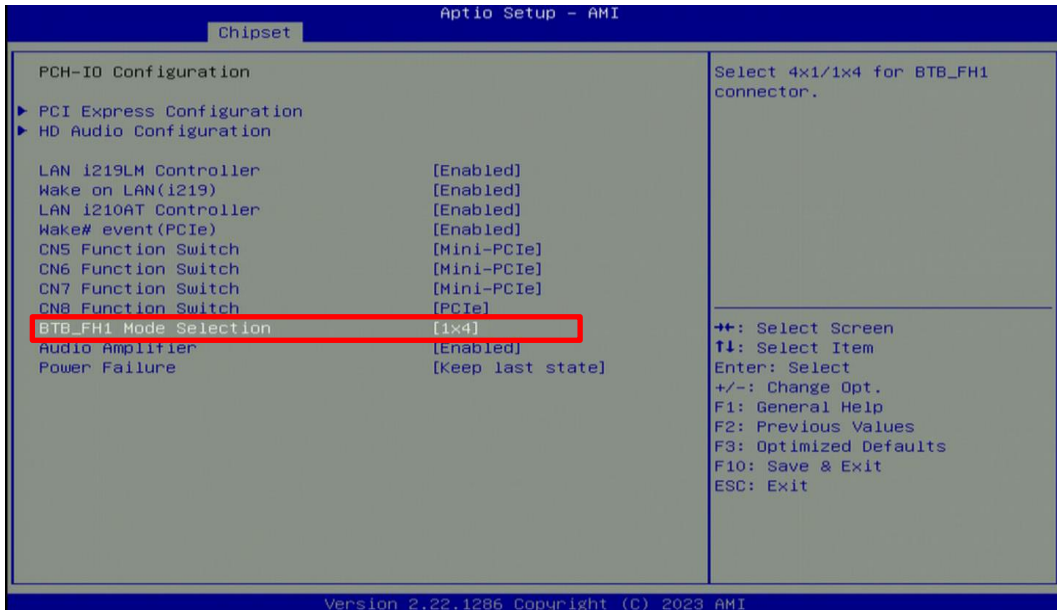

Step 1. Loosen the 2 hex nuts from back side of front bezel. Remove the front bezel.



Step 2. Attach the CMI-10GLAN bracket, and fasten the 2 hex nuts to fix it as indicated.



Step 3. Locate the connector of CMI-10GLAN module on top side of system. (Only the BTB_FH1 connector supports the CMI-10GLAN module. Select this connector precisely to install the module.)

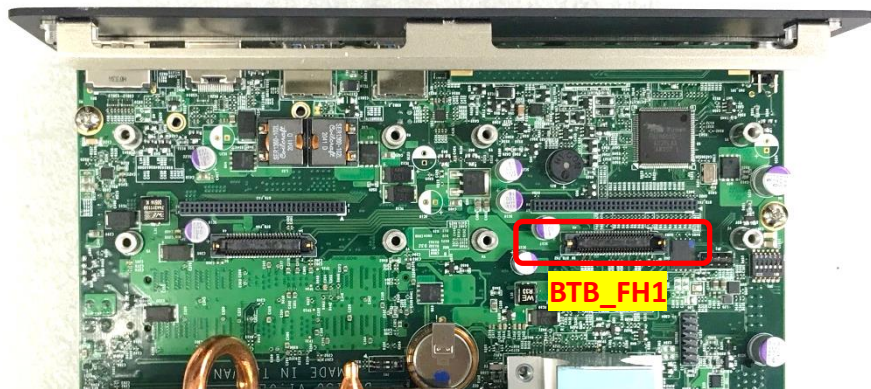

Step 4. Locate the chip place on the CMI-10GLAN module marked by red square. Paste the thermal pad on it carefully.

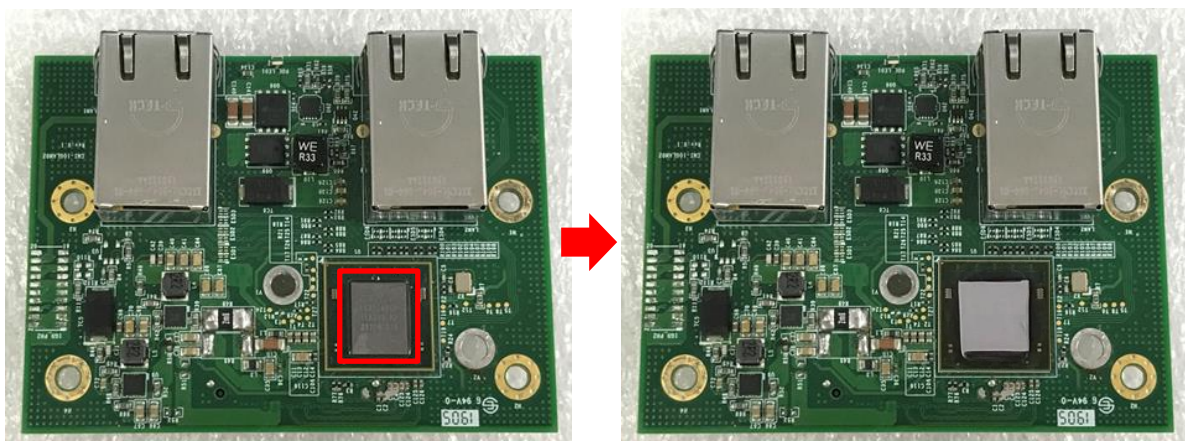

CAUTION
(ATTENTION)

Before putting on the heatsink (in the next step), please make sure the protective film on the Thermal Pad has been removed!

(Avant de mettre le bloc thermique (à l'étape suivante), veuillez vous assurer que le film protecteur sur le coussin thermique a été retiré!)

Step 5. Put on the heatsink and turn over the module. Fasten the screw to fix the heatsink.

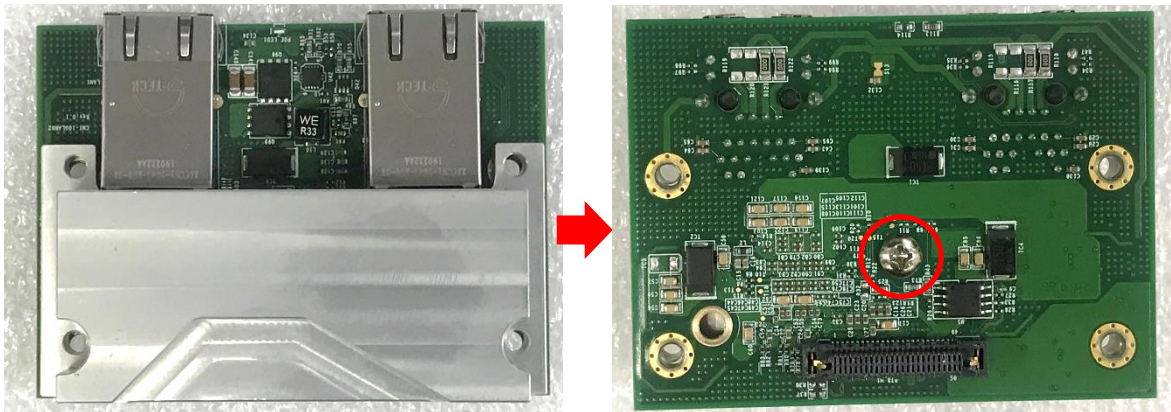

Step 6. Insert the CMI module vertically into the female connector on system's mainboard until it's connected firmly and fasten 4 screws to fix it.

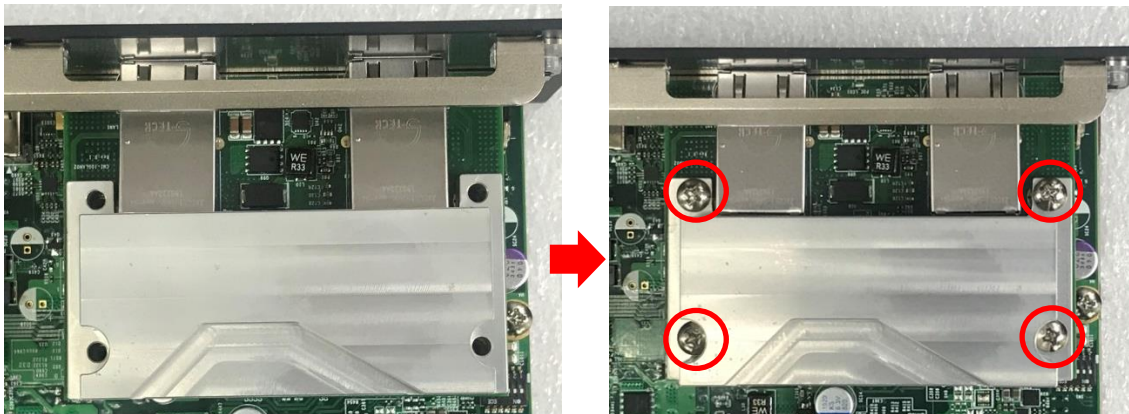

Step 7. Paste the thermal pad onto the heatsink carefully.



CAUTION
(ATTENTION)

Before assembling the system's chassis cover, please make sure the protective film on the Thermal Pad has been removed!
(Avant d'assembler le couvercle du châssis du système, assurez-vous que le film protecteur sur le coussin thermique a été retiré !)

3.15.5 CMI-DIO02/UB1018 Module

Step 1. Loosen the 2 hex nuts from back side of front bezel. Remove the front bezel.



Step 2. Attach the CMI-DIO bracket, and fasten the 2 hex nuts to fix it as indicated.

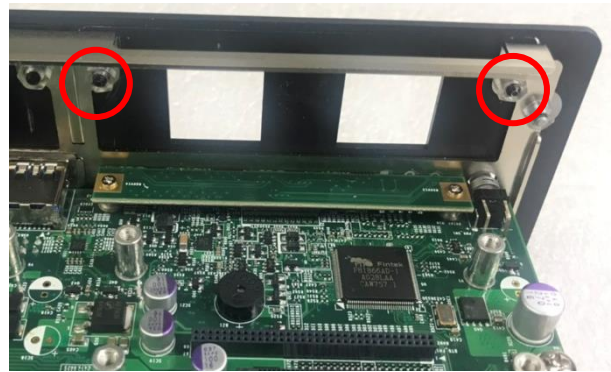

Step 3. Locate the connector(s) of CMI-DIO module on top side of system.

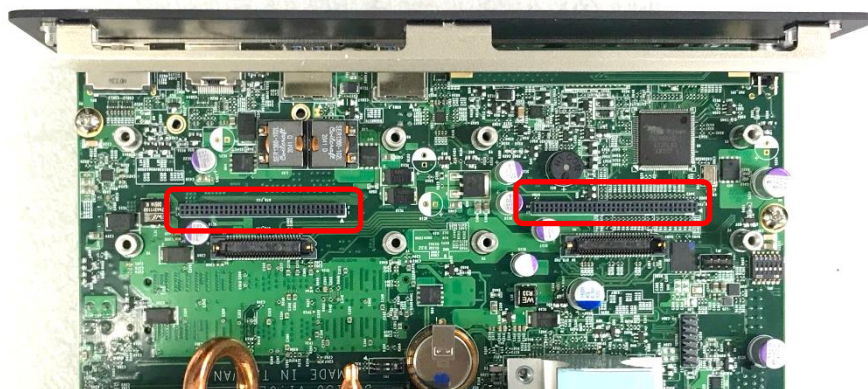

Step 4. Insert the CMI module vertically into the female connector on system's mainboard until it's connected firmly and fasten the 2 screws to fix it.

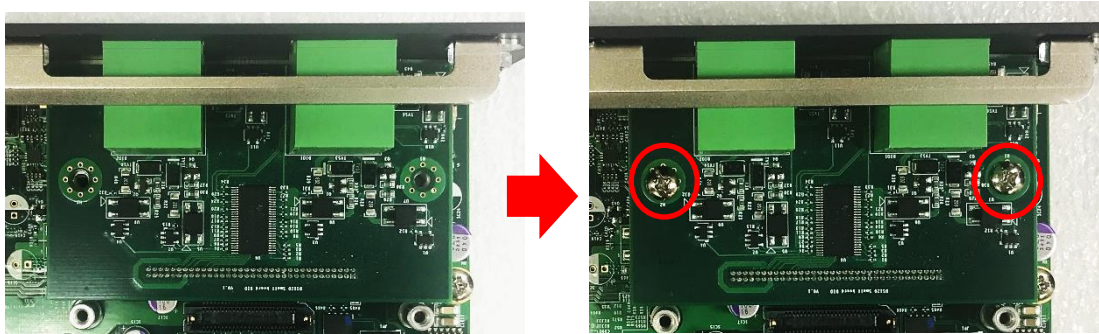

3.15.6 CMI-COM02/UB1004 Module

Step 1. Loosen the 2 hex nuts from back side of front bezel. Remove the front bezel.

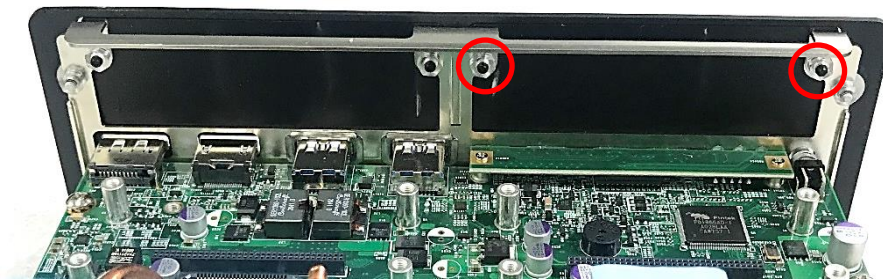

Step 2. Locate the connector(s) of the CMI-COM module on the top side of the system. Choose one connector to install the module.

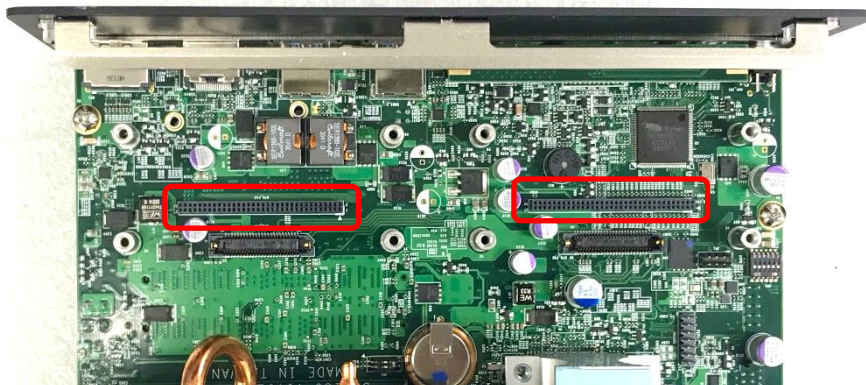

**NOTE
(NOTE)**

DS-1400 series supports one CMI-COM module installed on the system at most.

(La série DS-1400 prend en charge au maximum un module CMI-COM installé sur le système.)

Step 3. Penetrate the COM ports of the CMI-COM module through the holes on the bracket. Insert the CMI module vertically into the female connector on system's mainboard until it's connected firmly and fasten 2 screws to fix it.

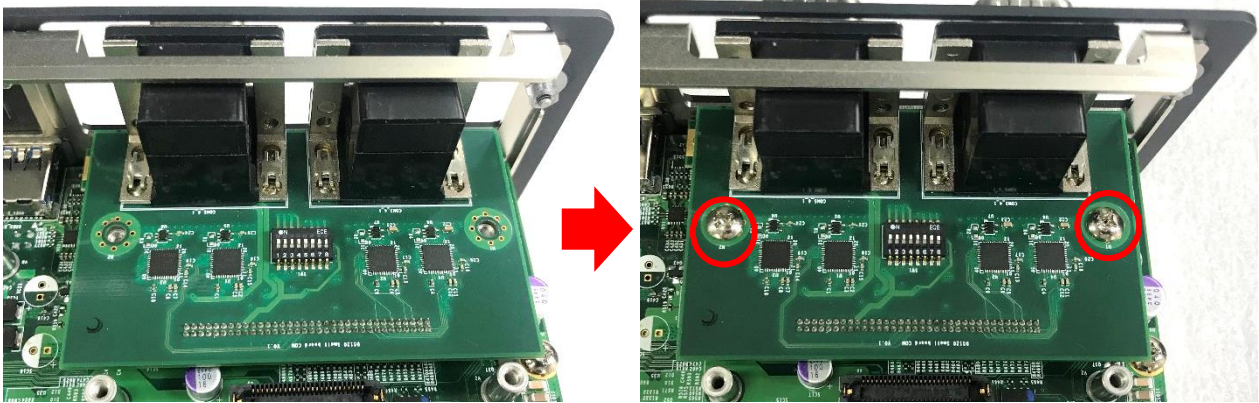

Step 4. Attach the CMI-COM bracket, and fasten the 2 hex nuts to fix it as indicated.

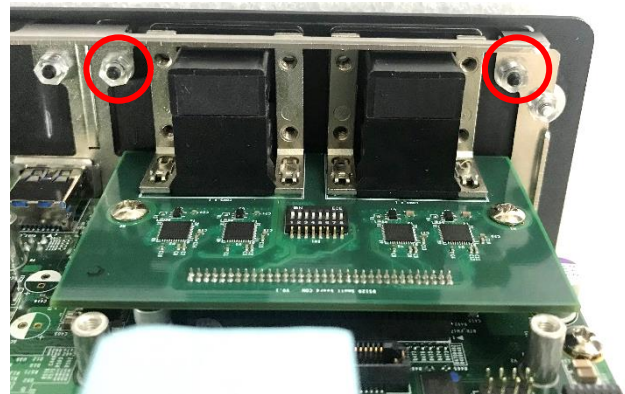

Step 5. Fasten the 8 D-Sub jack screws to fix the module.



3.15.7 CMI-ICOM01/UB1004 Module

Step 1. Loosen the 2 hex nuts from back side of front bezel. Remove the front bezel.

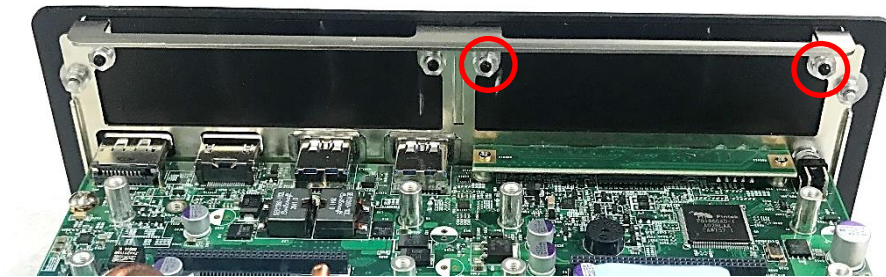

Step 2. Locate the connector(s) of the CMI-ICOM module on the top side of the system. Choose one connector to install the module.

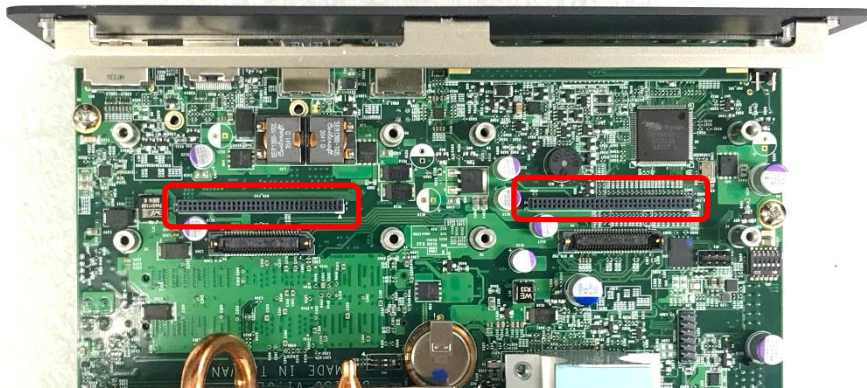

**NOTE
(NOTE)**

DS-1400 series supports one CMI-ICOM module installed on the system at most.

(La série DS-1400 prend en charge au maximum un module CMI-ICOM installé sur le système.)

Step 3. Penetrate the COM ports of the CMI-ICOM module through the holes on the bracket. Insert the CMI module vertically into the female connector on system's mainboard until it's connected firmly and fasten 2 screws to fix it.

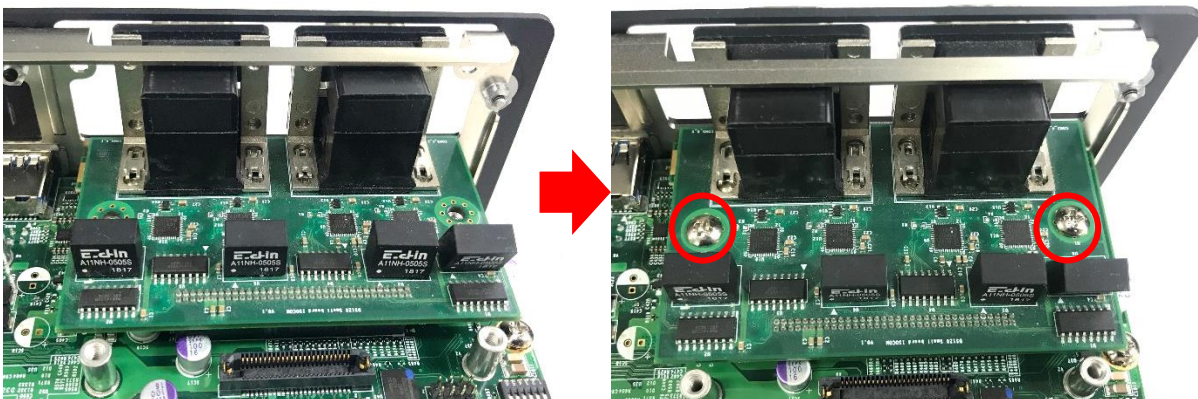

Step 4. Attach the CMI-ICOM bracket, and fasten the 2 hex nuts to fix it as indicated.

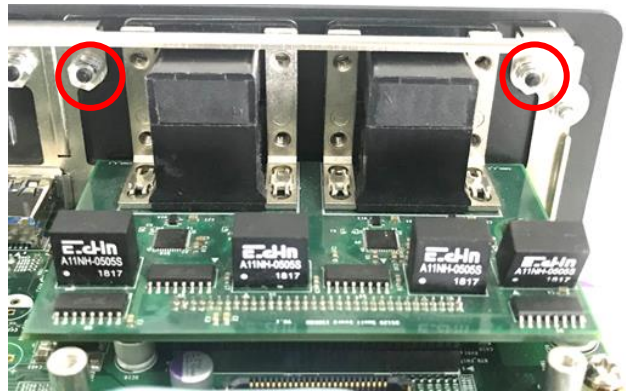

Step 5. Fasten the 8 D-Sub jack screws to fix the module.



3.16 Installing CFM Modules

3.16.1 CFM-PoE03 Module

CFM-PoE03 module can be installed on CMI-LAN or CMI-M12LAN module. When using CMI-LAN01-R12 Module, please paste the shading tape to the place which was marked by red frame. (Watch out not to block the LED.) If you use CMI-M12LAN01-R12 Module, please skip this step.

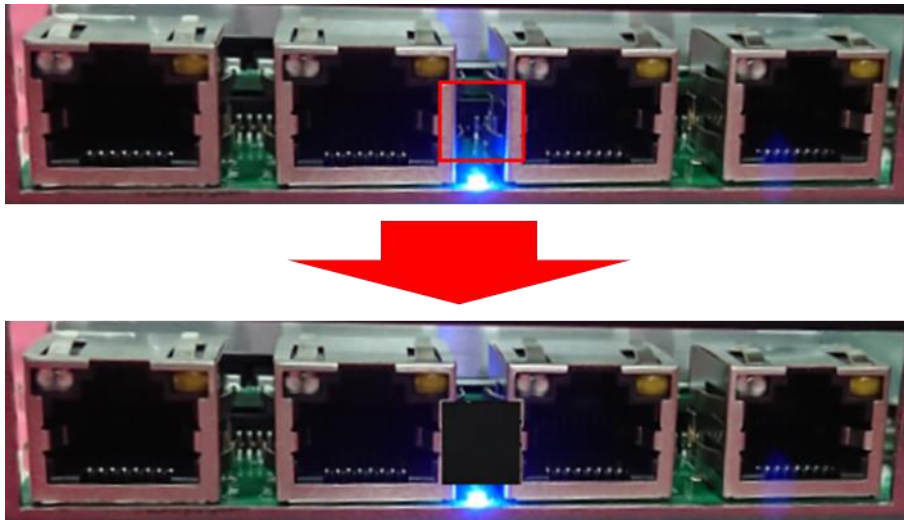

In this chapter, CMI-M12LAN module is taken as an example to demonstrate how to install CFM-PoE03 on it. Before this chapter gets started, please execute the installation step 1 to step 4 in chapter 3.15.2 in advance.

Step 1. Penetrate the CMI-M12LAN ports through the holes on the bracket. Insert the CMI module vertically into the female connector on system's mainboard until it's connected firmly and fasten 4 copper pillars to fix CMI-M12LAN module.

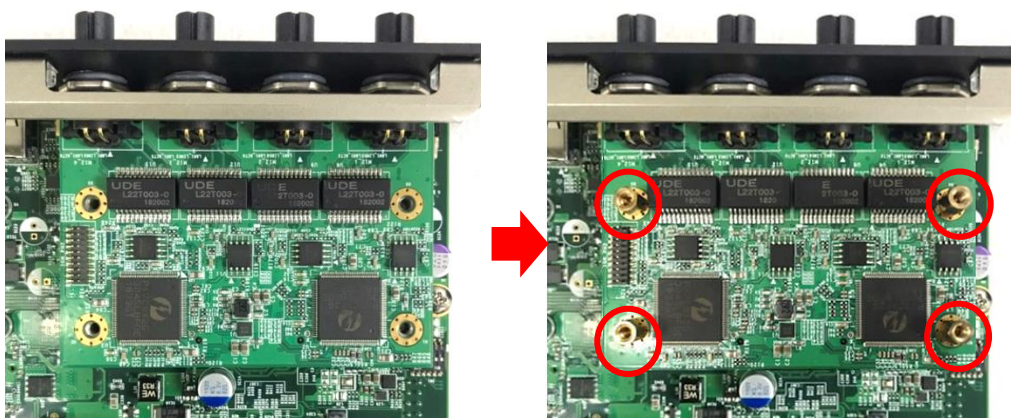

Step 2. Insert the CFM-PoE03 module vertically into the female connector on CMI module until it's connected firmly.



Step 3. Please paste the one thermal pad onto the coil of the CFM-PoE03 module carefully, and then remove the protective film on it.



Step 4. Turn over the heatsink and locate the two places which were marked by red circles, and then paste the 2 thermal pads onto the heatsink carefully.

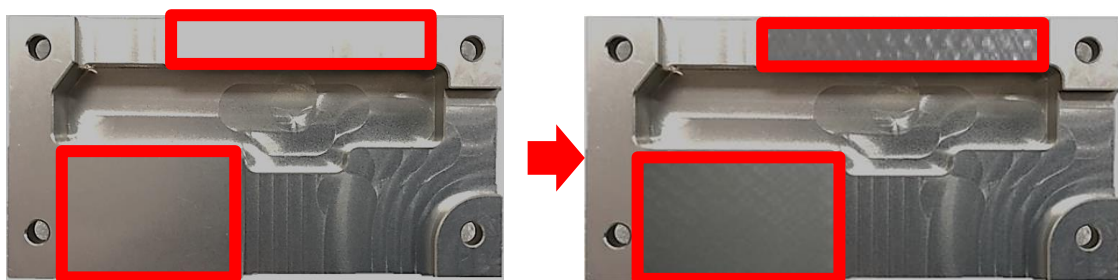

CAUTION
(ATTENTION)

Before putting on the heatsink (in the next step), please make sure the protective film on the Thermal Pad has been removed!

(Avant de mettre le bloc thermique (à l'étape suivante), veuillez vous assurer que le film protecteur sur le coussin thermique a été retiré!)

Step 5. Please paste the heatsink onto the CFM-PoE03 module carefully, and fasten 4 screws to fix it.

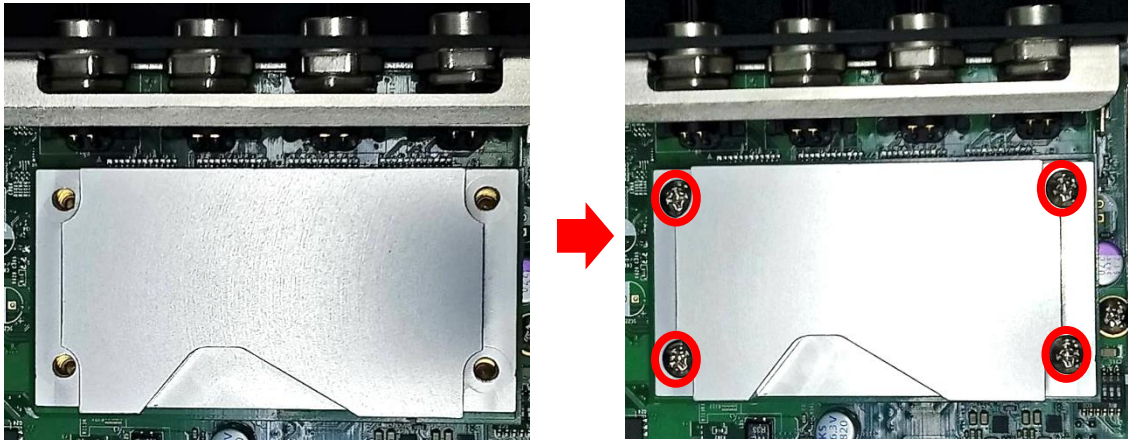

Step 6. Paste the thermal pad onto the heatsink carefully, and execute the step 6 in Chapter 6.2.2.

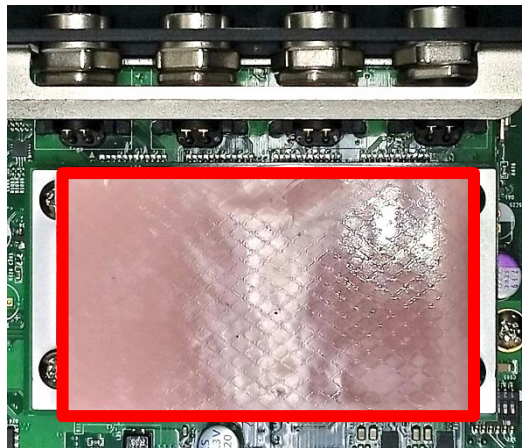

**CAUTION
(ATTENTION)**

Before assembling the system's chassis cover, please make sure the protective film on the Thermal Pad has been removed!

(Avant d'assembler le couvercle du châssis du système, assurez-vous que le film protecteur sur le coussin thermique a été retiré !)

Once the steps are finished, after system power on, PoE LED (on CMI-LAN or CMI-M12 LAN module) will light blue as shown below.



3.16.2 CFM-IGN101 Module

Step 1. Locate the power Ignition connector on the bottom side of the system.

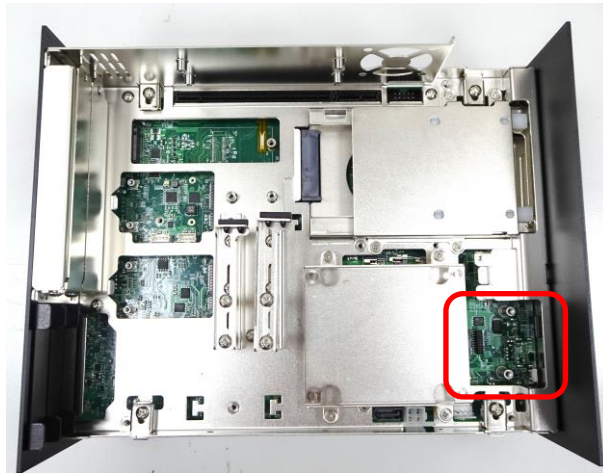

Step 2. Insert the connector of IGN module to the female connector on system motherboard. (Make sure all the pins of IGN module's connector are firmly connected.)



Step 3. Fasten the two screws to secure the power ignition board.



3.17 Installing MEC Modules

3.17.1 MEC-COM-M212-DB9/UB0303 Module

Step 1. Loosen 4 screws on the two cover plates of number 3/4/5 and then remove it. In the following steps, we use cover plate 4 and 5 for example. (To perform this step, users must remove both cover plates located on the rear side of the DS-1400 or DS-1401 system. For more detailed information, please refer to the Ordering Information section of the DS-1400 or DS-1401 datasheet.)

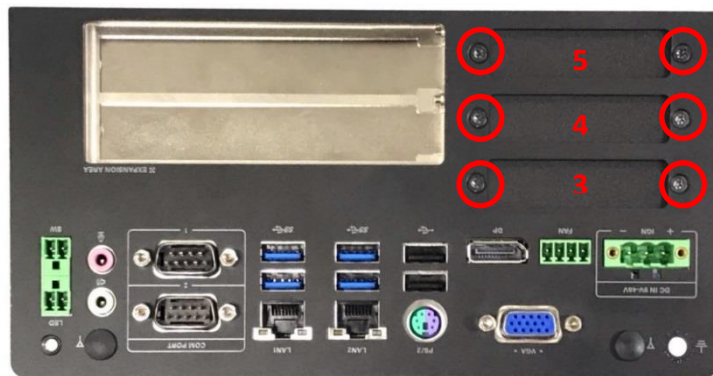

Step 2. Attach the MEC-COM brackets, and fasten the 4 screws to fix it as indicated.

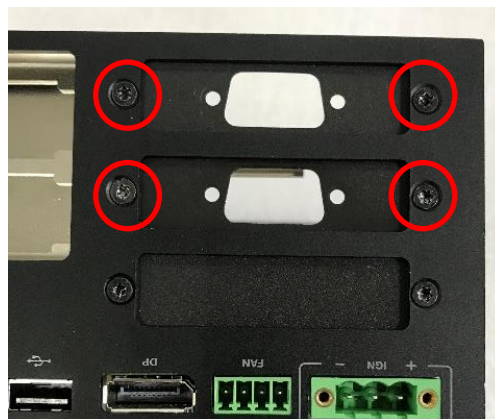

Step 3. Locate one of the Mini PCIe sockets on the bottom side of the system. In this chapter, we use CN6 for example.

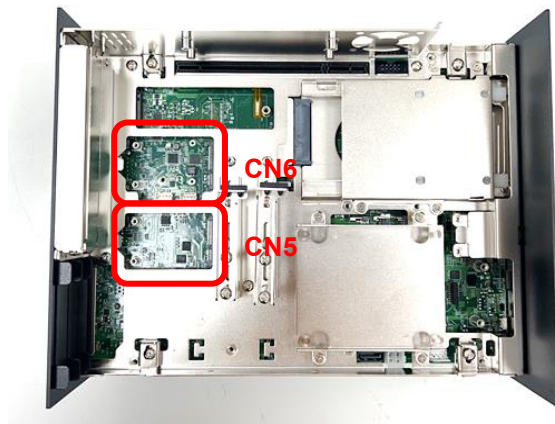

Step 4. Tilt the Mini PCIe card at a 45-degree angle and insert it to the socket until the golden finger connector of the card seated firmly.



Step 5. Press the card down and secure it with 2 screws.

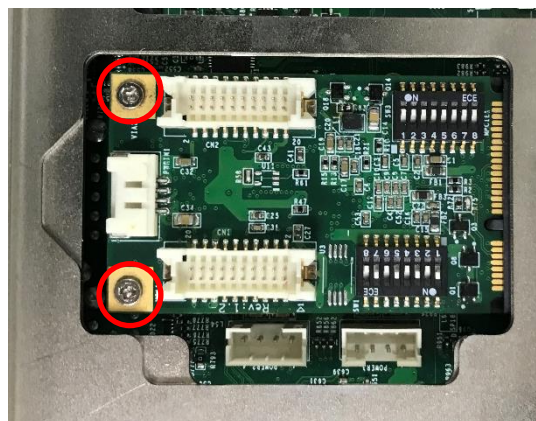

Step 6. Remove the 4 D-Sub jack screws from the COM ports.

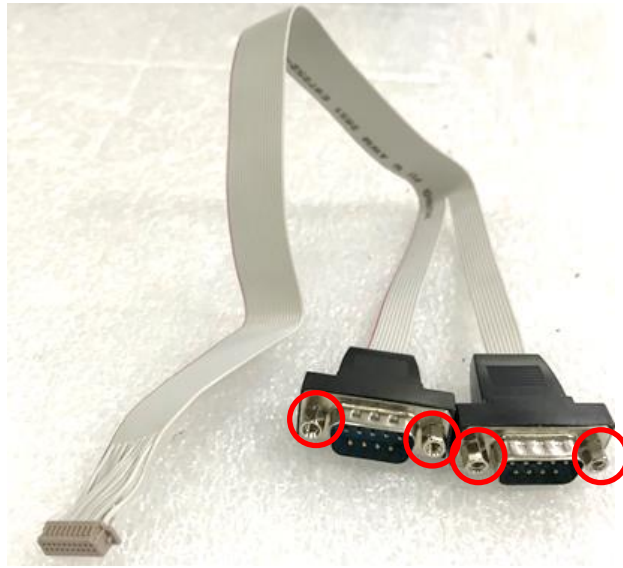

Step 7. Connect the other end of the wire to the Mini PCIe card as indicated.

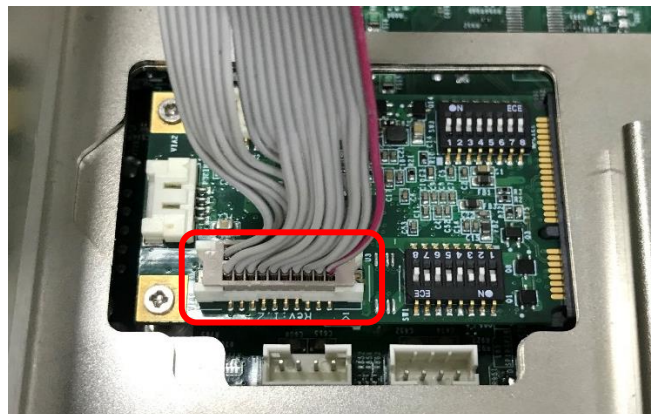

Step 8. Attach the COM ports onto the back side of the cover plates, and then fasten the 4 D-Sub jack screws to secure the COM ports.

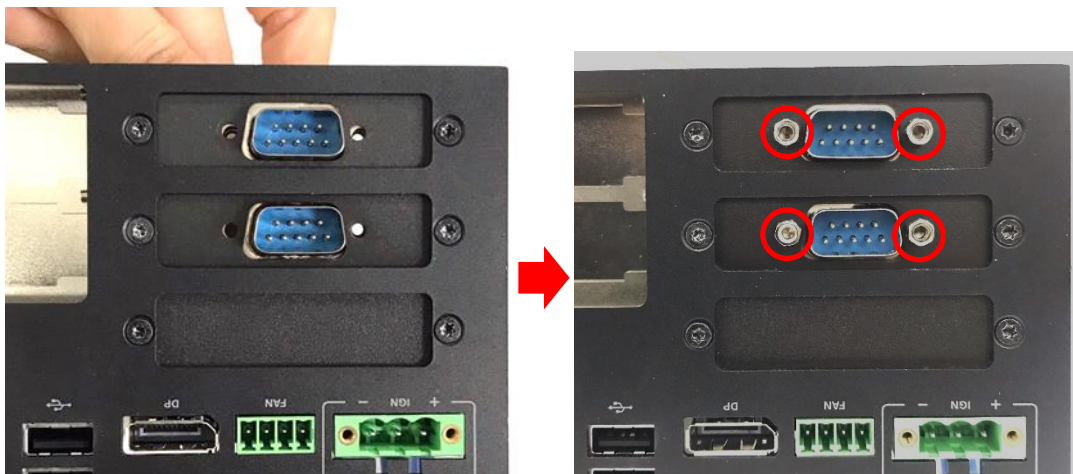

3.17.2 MEC-USB-M102-30/UB0314 Module

Step 1. Loosen 2 screws on the cover plate of number 3/4/5 and then remove it. In the following steps, we use cover plate 5 for example.

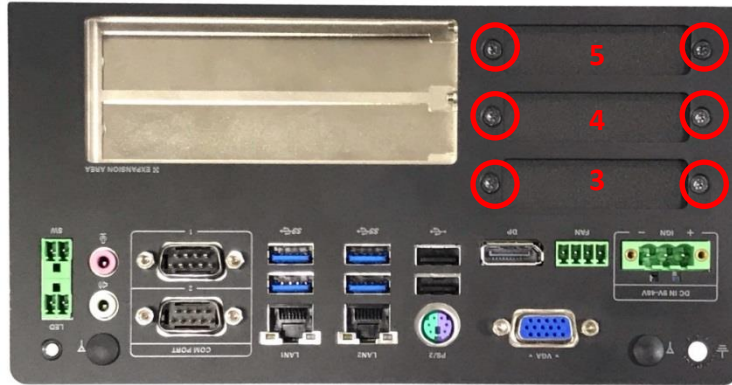

Step 2. Attach the MEC-USB bracket, and fasten the 2 screws to fix it as indicated.

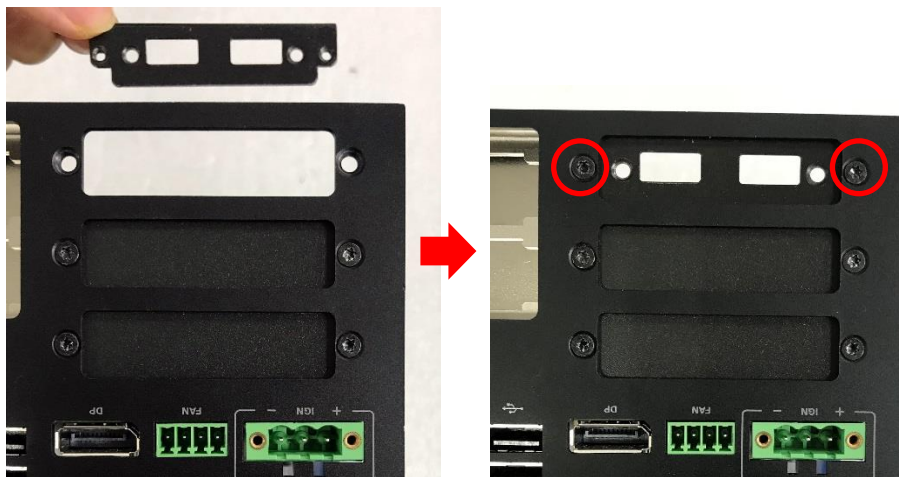

Step 3. Locate one of the Mini PCIe sockets on the bottom side of the system. In this chapter, we use CN6 for example.

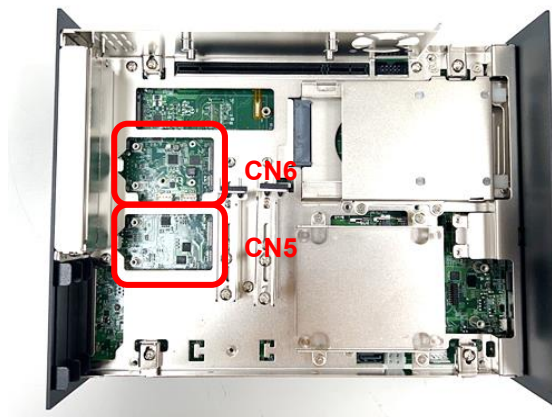

Step 4. Tilt the Mini PCIe card at a 45-degree angle and insert it to the socket until the golden finger connector of the card seated firmly.



Step 5. Press the card down and secure it with 2 screws.

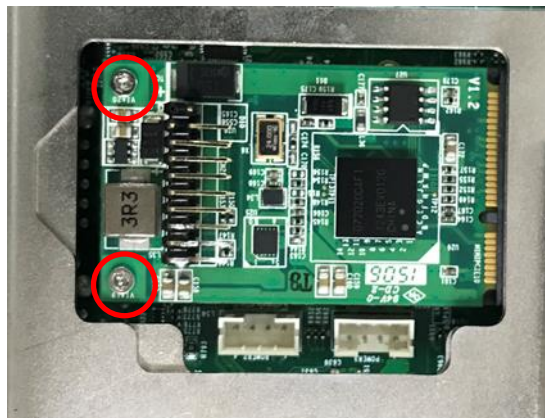

Step 6. Connect the attached wire to the USB board.



Step 7. Connect the other end of the wire to the Mini PCIe card as indicated.

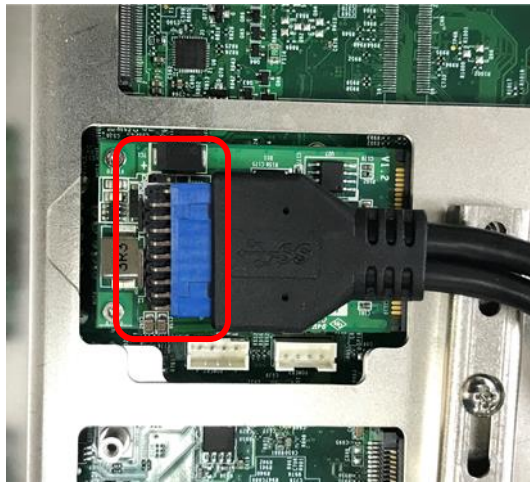

Step 8. Attach the USB board onto the back side of the cover plate, and then fasten the two screws to secure the module.

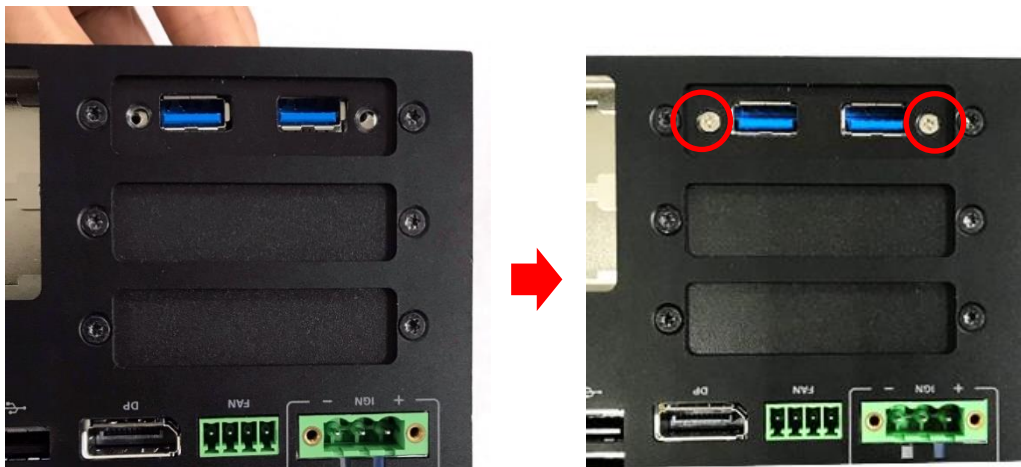

3.17.3 MEC-LAN-M102-30/UB0311 Module

Step 1. Loosen 2 screws on the cover plate of number 3/4/5 and then remove it. In the following steps, we use cover plate 5 for example.

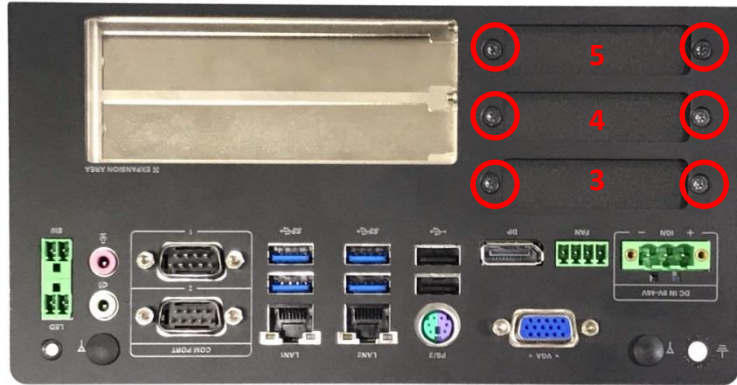

Step 2. Attach the MEC-LAN bracket, and fasten the 2 screws to fix it as indicated.

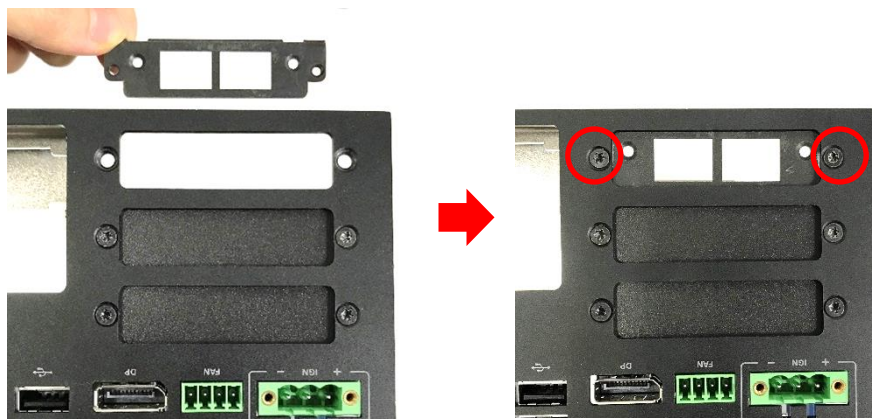

Step 3. Locate one of the Mini PCIe sockets on the bottom side of the system. In this chapter, we use CN6 for example.

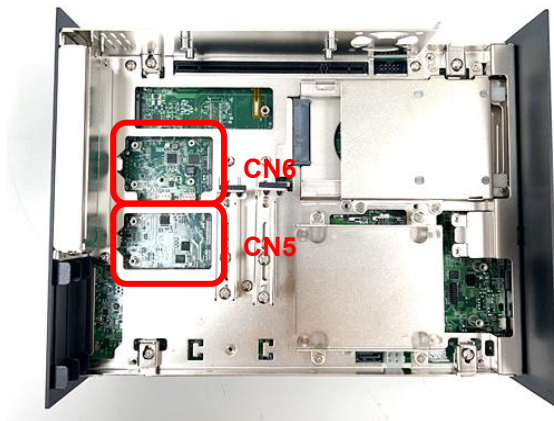

Step 4. Tilt the Mini PCIe card at a 45-degree angle and insert it to the socket until the golden finger connector of the card seated firmly.



Step 5. Press the card down and secure it with 2 screws.



Step 6. Connect the attached wires to the LAN board.



Step 7. Connect the wires to the Mini PCIe card as indicated.



Step 8. Attach the LAN board onto the back side of the cover plate, and then fasten the two screws to secure the module.



3.18 Installing External FAN

Model No.	Product Description
FAN-EX101	External Fan with 4pin Terminal Block Plug, Mounting Bracket. Support Smart Fan Function

Step 1. Prepare an external fan. Loosen the 2 screws halfway on mounting frame before attempting to install it.



Step 2. Slide the FAN into the middle groove of chassis as illustrated. Tighten the 2 screws to fix it onto chassis.

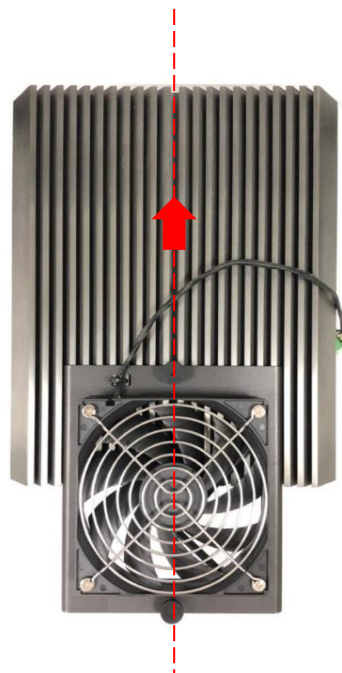

Step 3. Move the fan to the center of chassis. Tighten the 2 screws marked on photo to secure it.

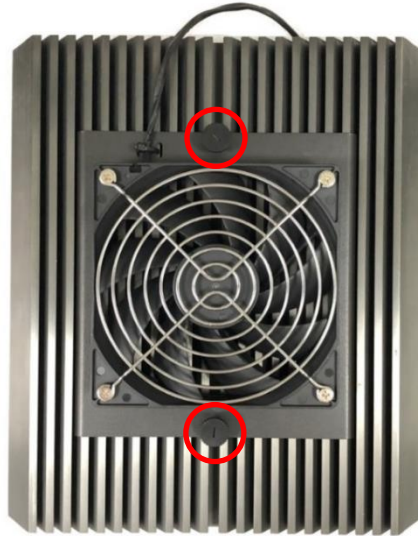

Step 4. Connect the FAN cable to external fan power connector at rear panel.



3.19 Installing Internal FAN

(For DS-1402 only)

Model No.	Product Description
FAN-UB100	Exhaling Fan with 4pin Connector, Universal Bracket
FAN-UB101	Inhaling Fan with 4pin Connector, Universal Bracket

Step 1. Unscrew 6 screws to remove 3 I/O brackets from rear panel.

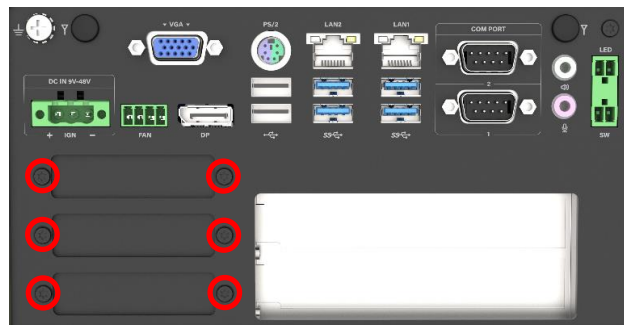

Step 2. Insert the fan connector to the power connector (power4).

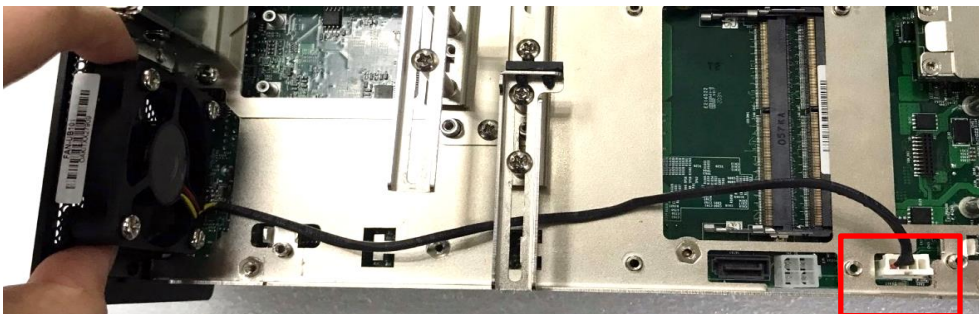

Step 3. Attach the FAN from back side of rear panel, and then fasten the 4 screws to fix it.

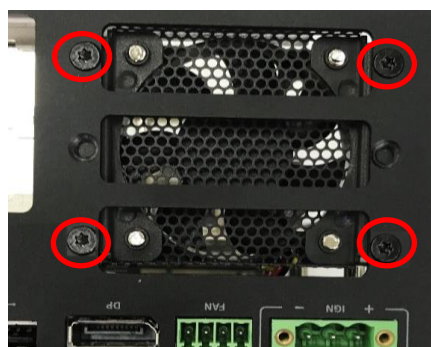

Step 4. User can use cable ties to tie the wire from the cut holes as indicated.

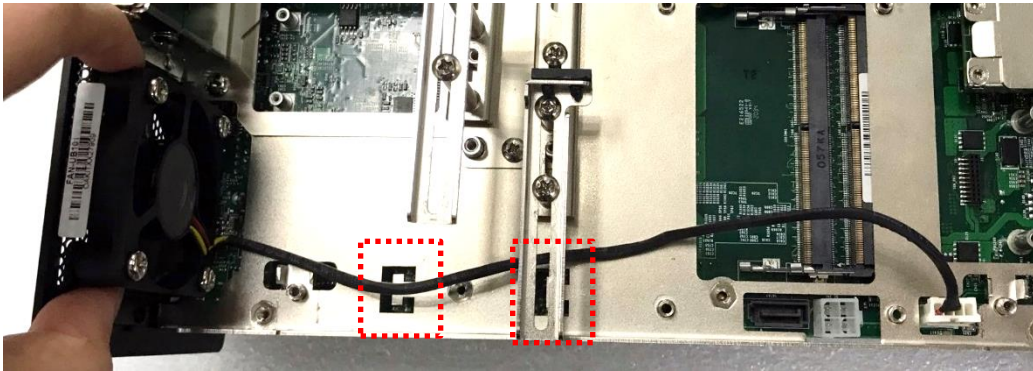



Chapter 4

BIOS Setup

4.1 BIOS Introduction

The BIOS (Basic Input/ Output System) is a program located on a Flash Memory on the motherboard. When you start the computer, the BIOS program will gain control. The BIOS first operates an auto-diagnostic test called POST (power on self-test) for all the necessary hardware, it detects the entire hardware device and configures the parameters of the hardware synchronization.

BIOS Setup

Power on the computer and by pressing immediately allows you to enter Setup. If the message disappears before your respond and you still wish to enter Setup, restart the system to try again by turning it OFF then ON or pressing <Ctrl>, <Alt> and <Delete> keys.

Control Keys	
<<> <>>	Move to select screen
<↑> <↓>	Move to select item
<Esc>	Quit the BIOS Setup
<Enter>	Select item
<Page Up/+>	Increases the numeric value or makes changes
<Page Down/->	Decreases the numeric value or makes changes
<Tab>	Select setup fields
<F1>	General help
<F2>	Previous value
<F3>	Load Optimized defaults
<F10>	Save configuration and Exit

Main Menu

The main menu lists the setup functions you can make changes to. You can use the arrow keys (↑ ↓) to select the item. The on-line description of the highlighted setup function is displayed at the bottom of the screen.

Sub-Menu

If you find a right pointer symbol appears to the left of certain fields that means a sub-menu can be launched from this field. A sub-menu contains additional options for a field parameter. You can use arrow keys (↑ ↓) to highlight the field and press <Enter> to call up the sub-menu. Then you can use the control keys to enter values and move from field to field within a sub-menu. If you want to return to the main menu, just press the <Esc >.

4.2 Main Setup

Press to enter BIOS CMOS Setup Utility, the Main Menu (as shown below) will appear on the screen. Use arrow keys to move among the items and press <Enter> to accept or enter a sub-menu.

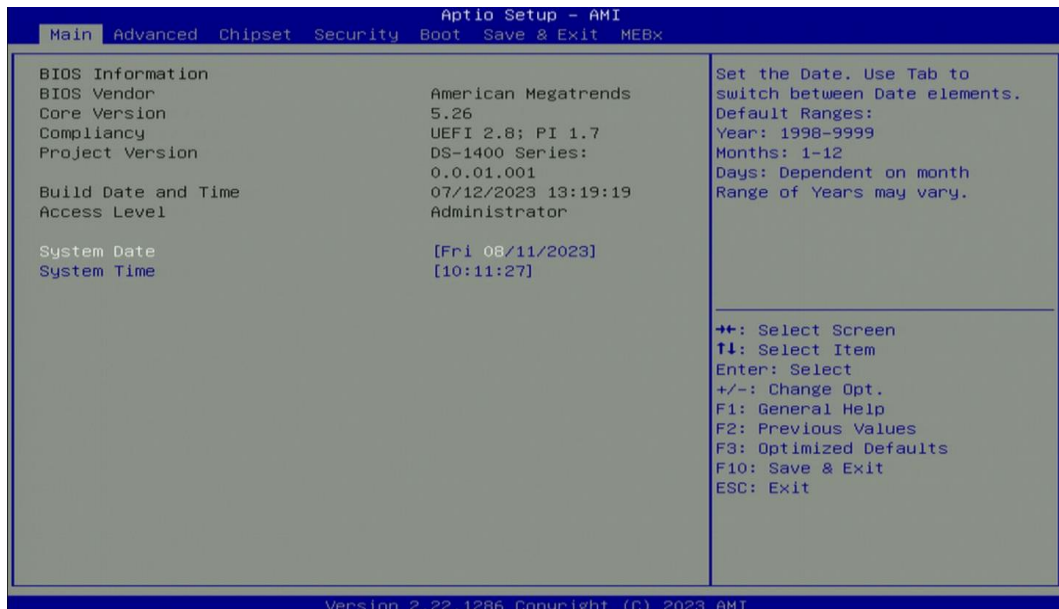

4.2.1 System Date

Set the date. Please use <Tab> to switch between date elements.

4.2.2 System Time

Set the time. Please use <Tab> to switch between time elements.

4.3 Advanced Setup

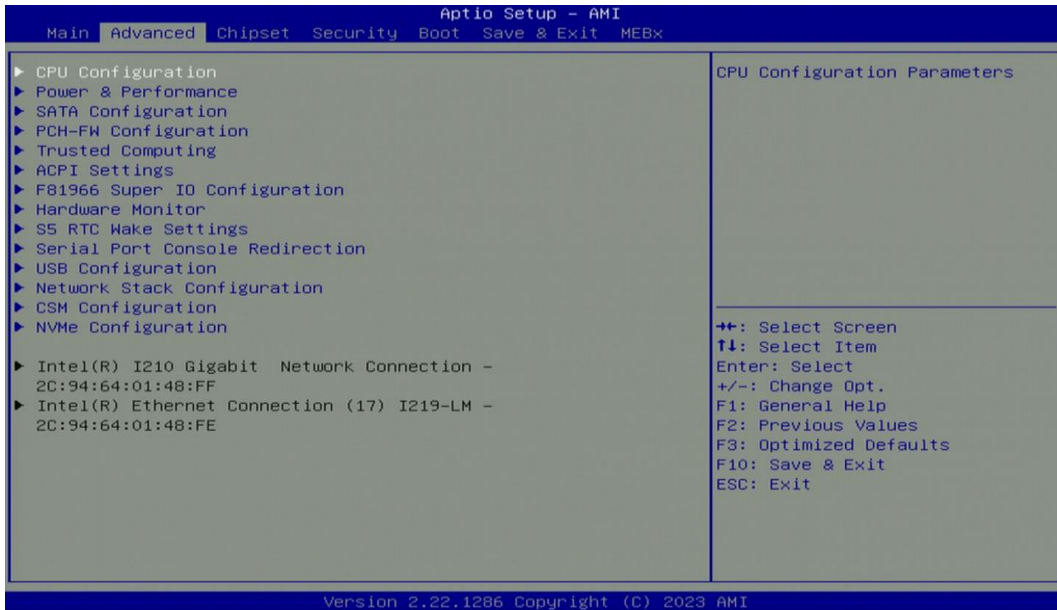

4.3.1 CPU Configuration



■ Performance-core Information



■ Intel® (VMX) Virtualization Technology [Enabled]

Enables or disables Intel® Virtualization Technology. Virtualization enhanced by Intel® Virtualization Technology will allow a platform to run multiple operating systems and applications in independent partitions. With virtualization, one computer system can function as multiple virtual systems.

■ Active Performance-cores [All]

Allows users to choose the number of active performance cores.

Configuration options: [All] [1] [2] [3] [4] [5]

■ Hyper-threading

Enables or disables for Hyper-Threading Technology.

4.3.2 Power & Performance



■ SKU Power Config [Auto]

Allows users to choose the upper limit of CPU power.

Configuration options: [Auto] [35W]

4.3.3 SATA Configuration

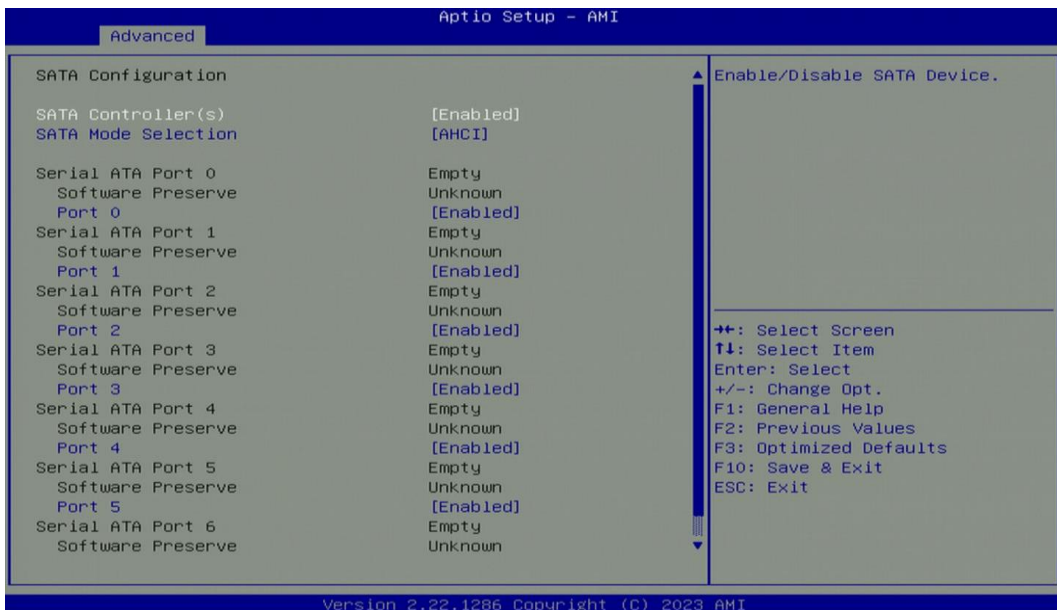

■ SATA Controller(s) [Enabled]

Enables or disables Serial ATA controller.

■ SATA Mode Selection [AHCI]

This item only allows users to choose [AHCI] mode.

Serial ATA Port 0

Port 0 [Enabled]

Enables or disables SATA Port 0.

- ❑ **Serial ATA Port 1**
Port 1 [Enabled]
Enables or disables SATA Port 1.
- ❑ **Serial ATA Port 2**
Port 2 [Enabled]
Enables or disables SATA Port 2.
- ❑ **Serial ATA Port 3**
Port 3 [Enabled]
Enables or disables SATA Port 3.
- ❑ **Serial ATA Port 4**
Port 4 [Enabled]
Enables or disables SATA Port 4.
- ❑ **Serial ATA Port 5**
Port 5 [Enabled]
Enables or disables SATA Port 5.

4.3.4 PCH-FW Configuration



■ Intel AMT [Enabled]

Allows users to enable or disable Intel® Active Management Technology BIOS execution.

■ Firmware Update Configuration

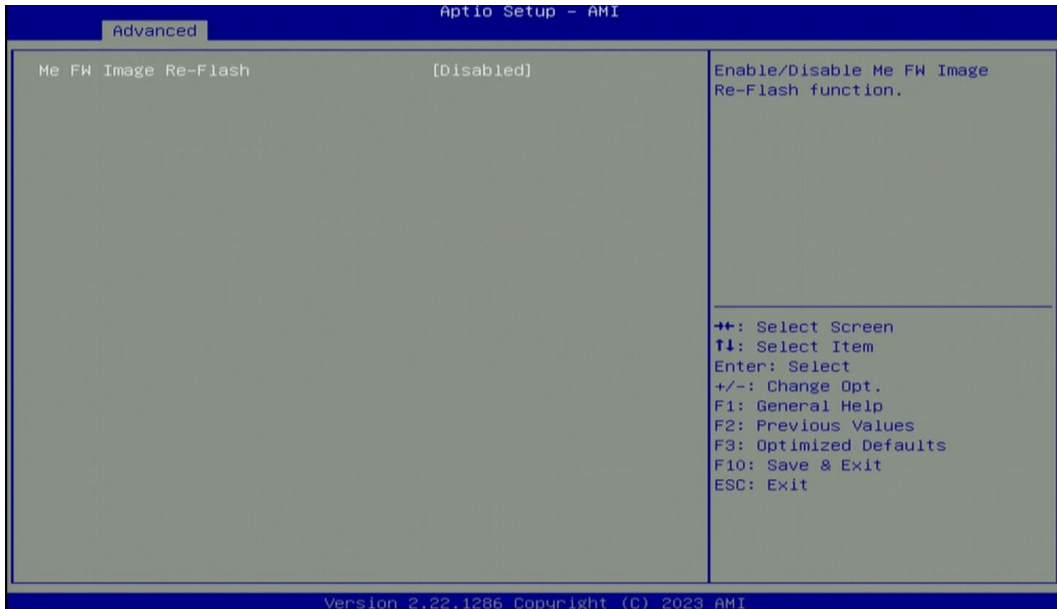

□ ME FW Image Re-Flash [Disabled]

Allows users to enable or disable ME firmware image re-flash function.

4.3.5 Trusted Computing

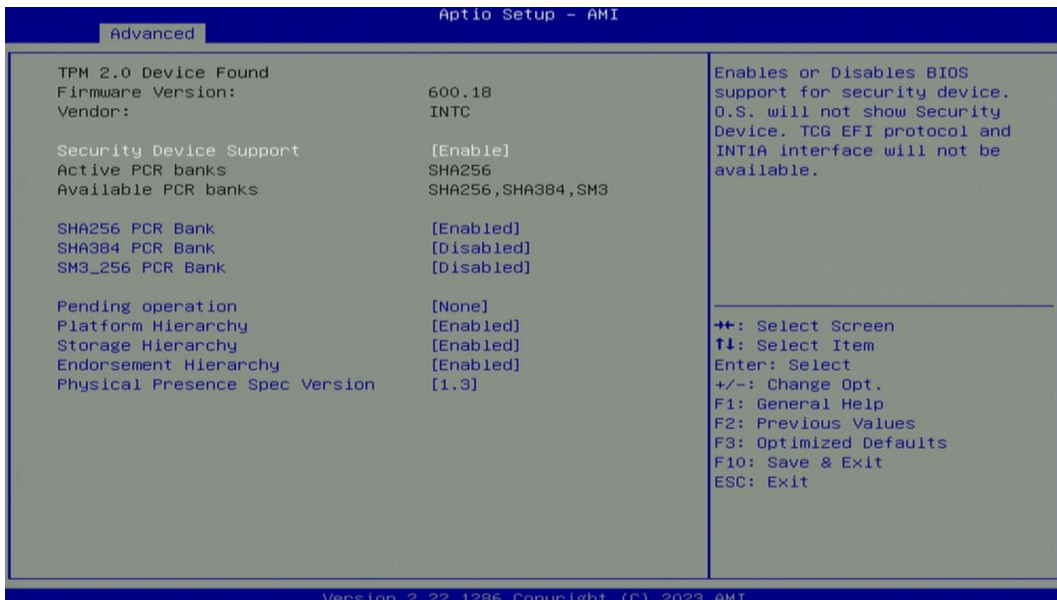

■ Security Device Support [Enable]

Allow users to enable or disable Security Device Support function.

■ SHA256 PCR Bank [Enabled]

Enables or disables SHA256 PCR Bank function.

■ **SHA384 PCR Bank [Disabled]**

Enables or disables SHA384 PCR Bank function.

■ **SHA3_256 PCR Bank [Disabled]**

Enables or disables SHA3_256 PCR Bank function.

■ **Pending Operation [None]**

Allows users to select which mode Pending Operation will operate.

Configuration options: [None], [TPM Clear]

■ **Platform Hierarchy [Enabled]**

Enables or disables Platform Hierarchy function.

■ **Storage Hierarchy [Enabled]**

Enables or disables Storage Hierarchy function.

■ **Endorsement Hierarchy [Enabled]**

Enables or disables Endorsement Hierarchy function.

■ **Physical Presence Spec Version [1.3]**

Allows users to select which mode Physical Presence Spec Version will operate.

Configuration options: [1.2], [1.3]

4.3.6 ACPI Settings

This item allows users to configure ACPI settings.



■ **Enable ACPI Auto Configuration [Enabled]**

Enables or disables BIOS Advanced Configuration Power Interface® (ACPI) auto configuration.

■ **ACPI Sleep State [S3 (Suspend to RAM)]**

Allows users to select the highest Advanced Configuration Power Interface® (ACPI) sleep state that system will enter when suspend button is pressed.

[Suspend Disabled]: Disables entering suspend state.

[S3 (suspend to RAM)]: Enables suspend to RAM state.

4.3.7 F81966 Super IO Configuration

The screen allows users to select options for the Super IO configuration, and change the value of the selected option.

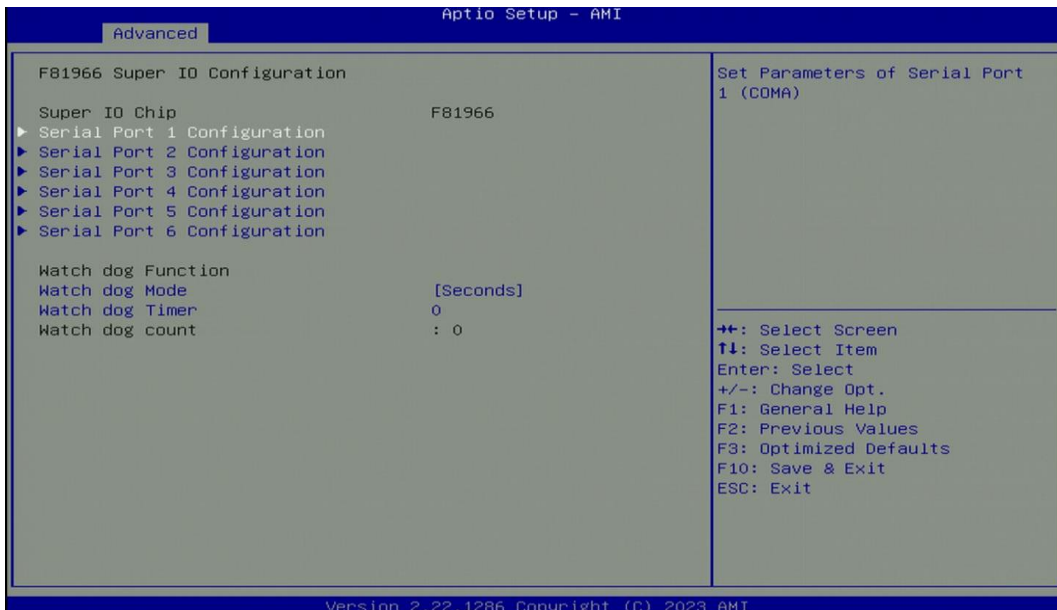

Serial Port 1~4 Configuration

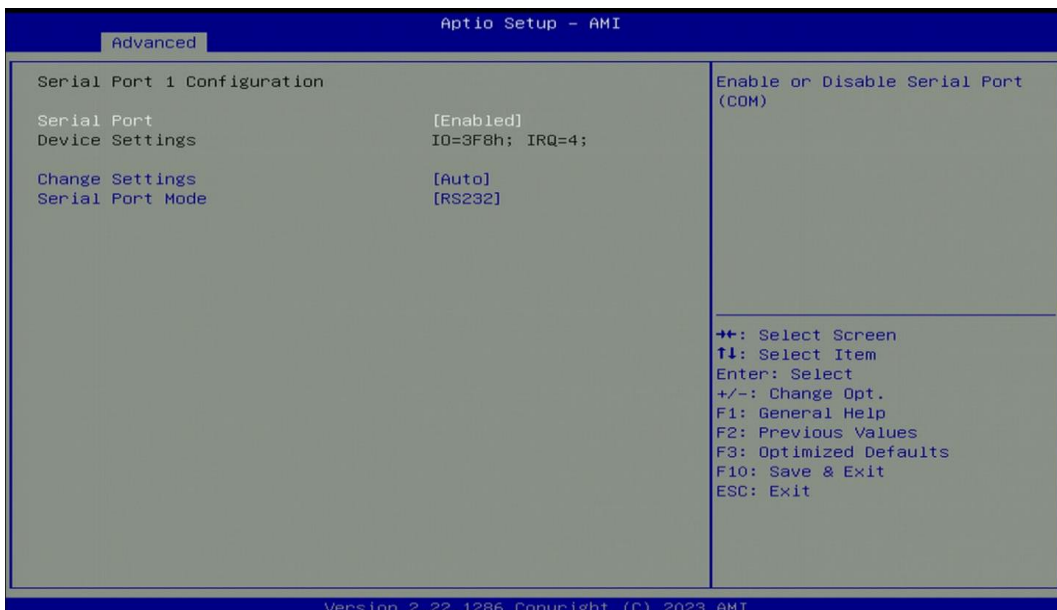

Serial Port [Enabled]

This item allows users to enable or disable serial port.

Change Settings [Auto]

This item allows users to change the address & IRQ settings of the specified serial port.

Onboard Serial Port 1 Mode [RS232]

This item allows users to select Serial Port Mode.

Configuration options: [RS232] [RS422/RS485 Full Duplex] [RS485 Half Duplex]

■ Watch Dog [Disabled]

Enables or disables watch dog function.

■ Watch Dog Mode [Sec]

Changes the Watch dog mode. Select [Sec] or [Min] mode.

■ Watch Dog Timer [0]

User can set a value in the range of 0 to 255.

4.3.8 Hardware Monitor

These items display the current status of all monitored hardware devices/ components such as voltages and temperatures.

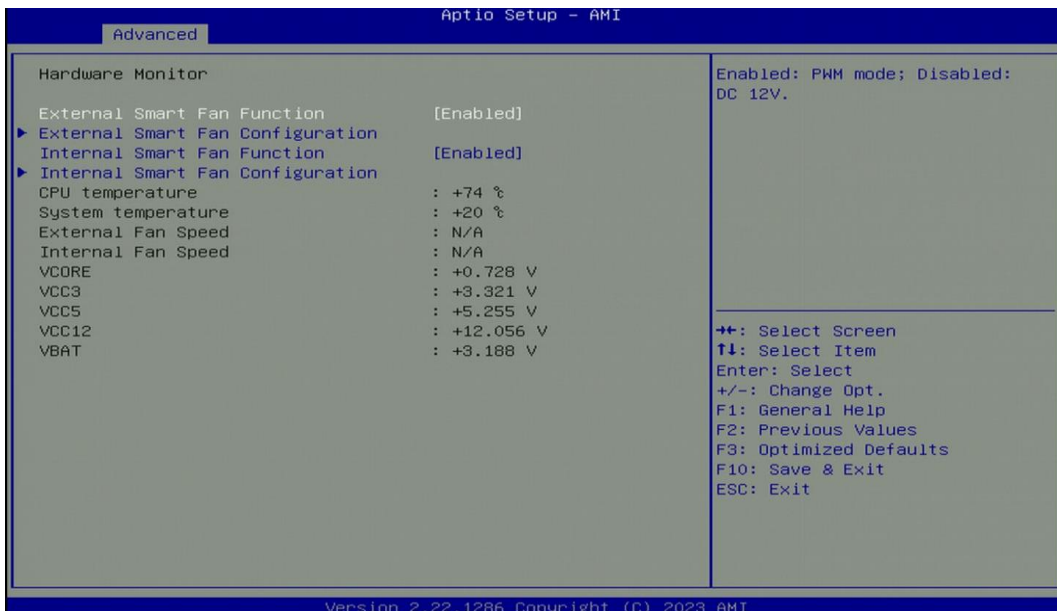

■ External Smart Fan Function [Enabled]

Enables or disables external smart fan function.

■ External Smart Fan Configuration

Allows users to setting external smart fan parameters.

■ Internal Smart Fan Function [Enabled]

Enables or disables internal smart fan function.

■ Internal Smart Fan Configuration

Allows users to setting internal smart fan parameters.

4.3.9 S5 RTC Wake Settings

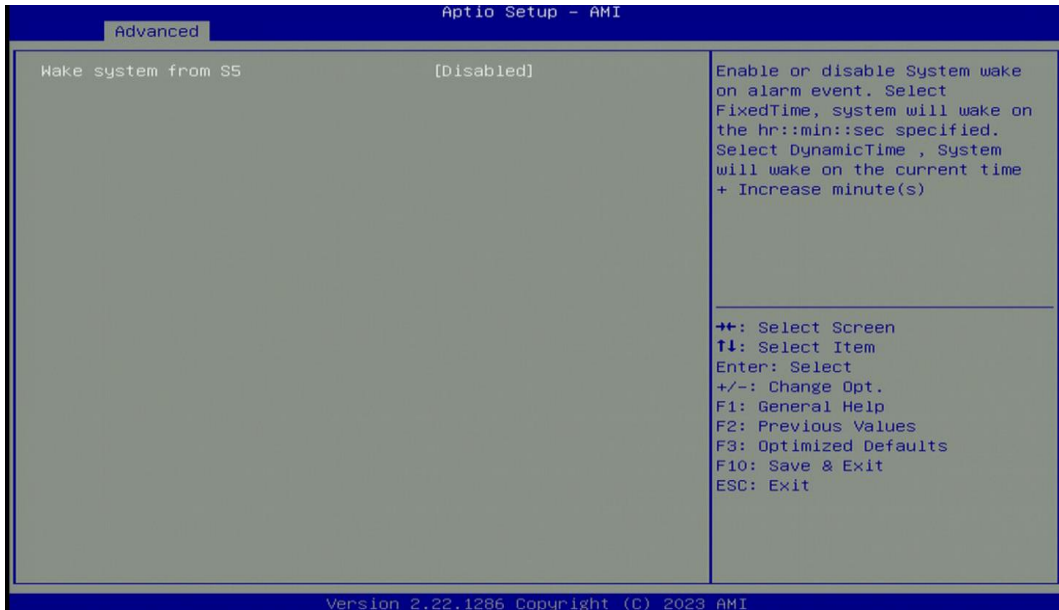

Wake System from S5 [Disabled]

This item allows users to change the way to wake system from S5 state.

[Fixed Time]: Set the specified time (HH:MM:SS) to wake system.

[Dynamic Time]: Set the increase time from current time to wake system.

4.3.10 Serial Port Console Redirection

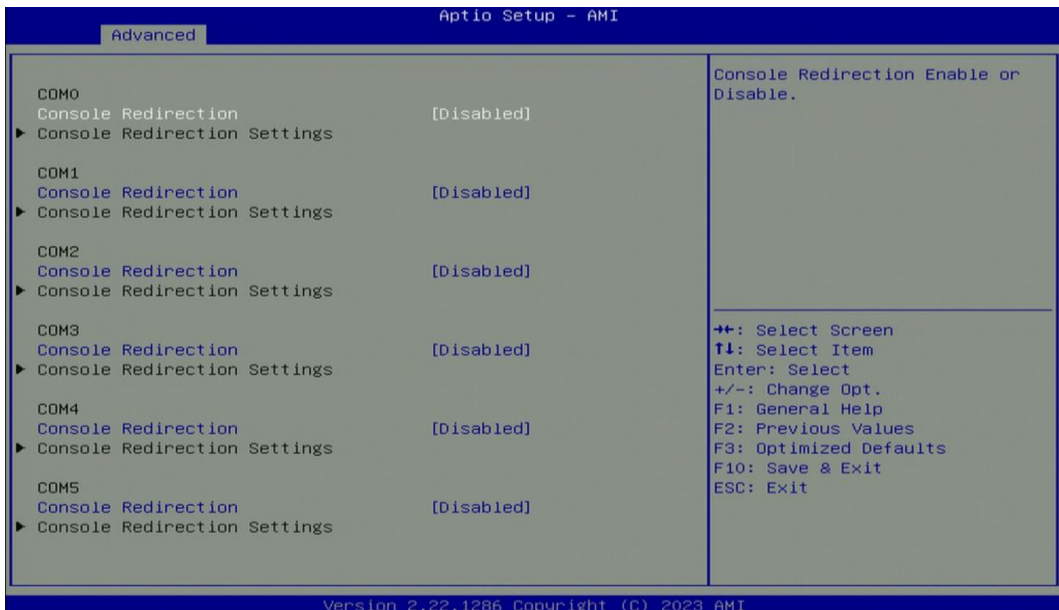

■ Console Redirection [Disabled]

These items allow users to enable or disable COM0, COM1, COM2, COM3, COM4, COM5 console redirection function.

4.3.11 USB Configuration

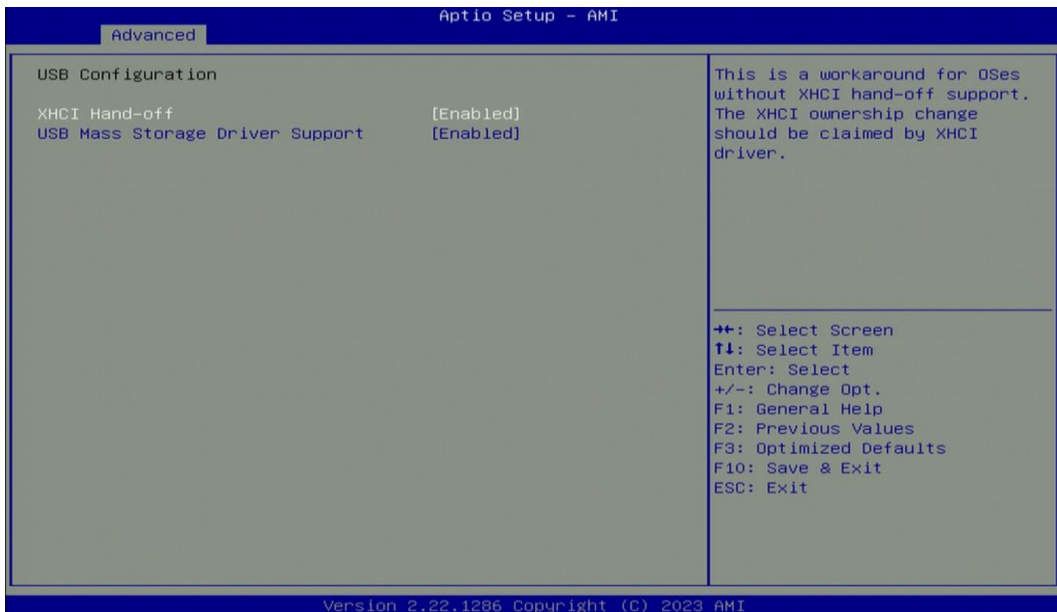

■ XHCI Hand-off [Enabled]

This item allows users to enable or disable XHCI (USB3.2) hand-off function.

■ USB Mass Storage Driver Support [Enabled]

Enables or disables support for USB mass storage devices.

4.3.12 Network Stack Configuration

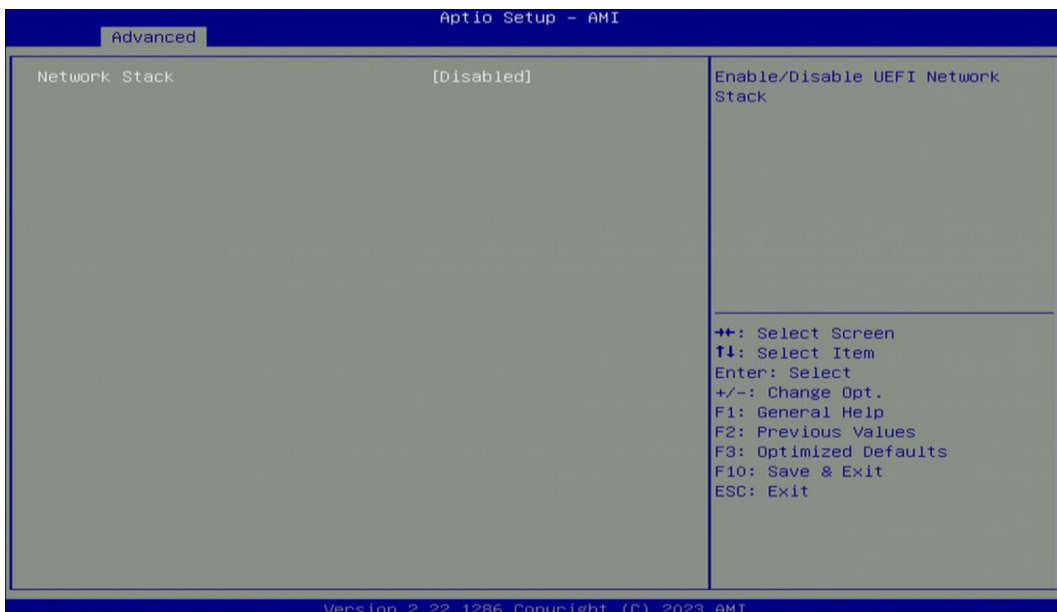

■ Network Stack [Disabled]

Enables or disables UEFI Network Stack.

4.3.13 CSM Configuration



■ CSM Support [Disabled]

Enables or disables compatibility support module.

4.3.14 NVMe Configuration

The screen allows users to select options for the NVMe configuration, and change the value of the selected option. If there is NVMe Device detected, the options will show as the NVMe Device is found.



4.4 Chipset Setup

This section allows you to configure chipset related settings according to user's preference.

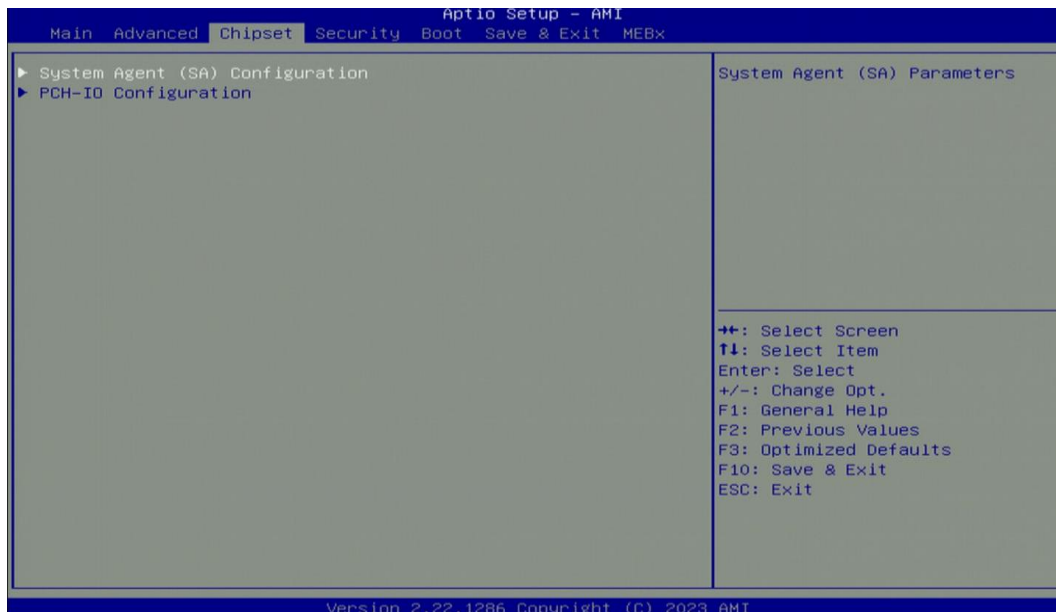

4.4.1 System Agent (SA) Configuration

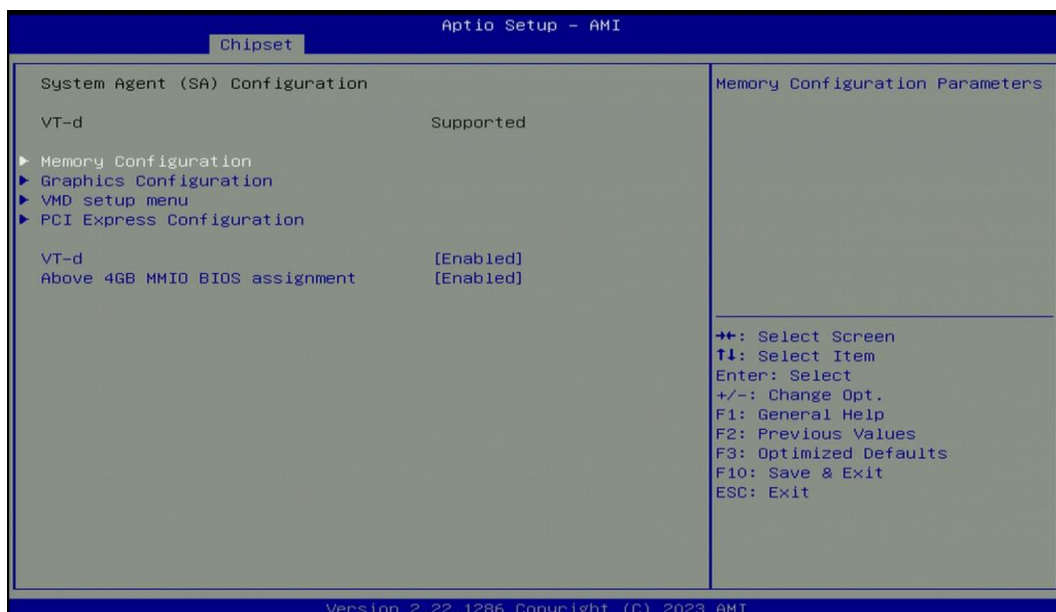

■ Memory Configuration

This item displays detailed memory information in the system.

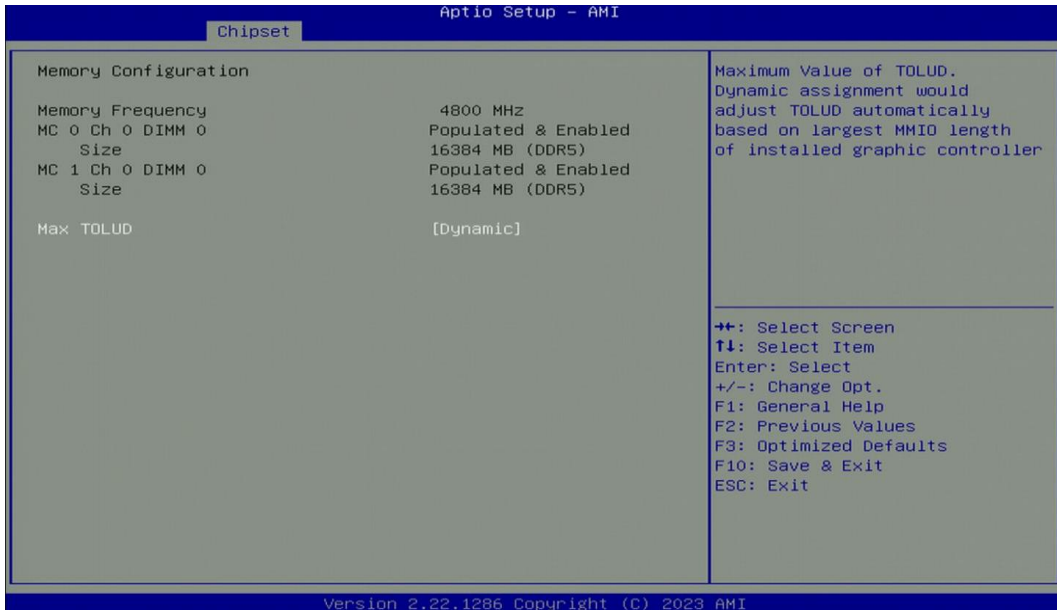

■ Graphics Configuration

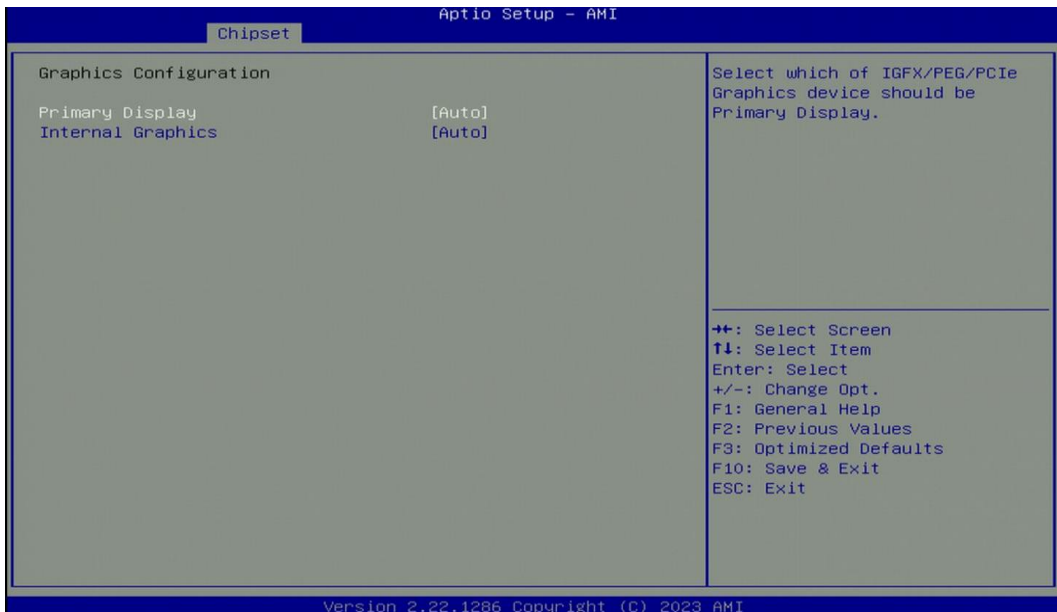

❑ Primary Display [Auto]

Allows users to select which graphics device should be primary display or select SG for switchable graphics.

Configuration options: [Auto] [IGFX] [PEG Slot] [PCIe]

❑ Internal Graphics [Auto]

This item allows users to enable or disable Internal Graphics. When set to [Auto], it will detect by BIOS. Configuration options: [Auto] [Disabled] [Enabled]

■ VMD Configuration



Enable VMD controller [Disabled]

Allows users to enable or disable VMD Controller.

Configuration options: [Disabled] [Enabled]

Enable this function can support creating RAID.

■ PCI Express Configuration

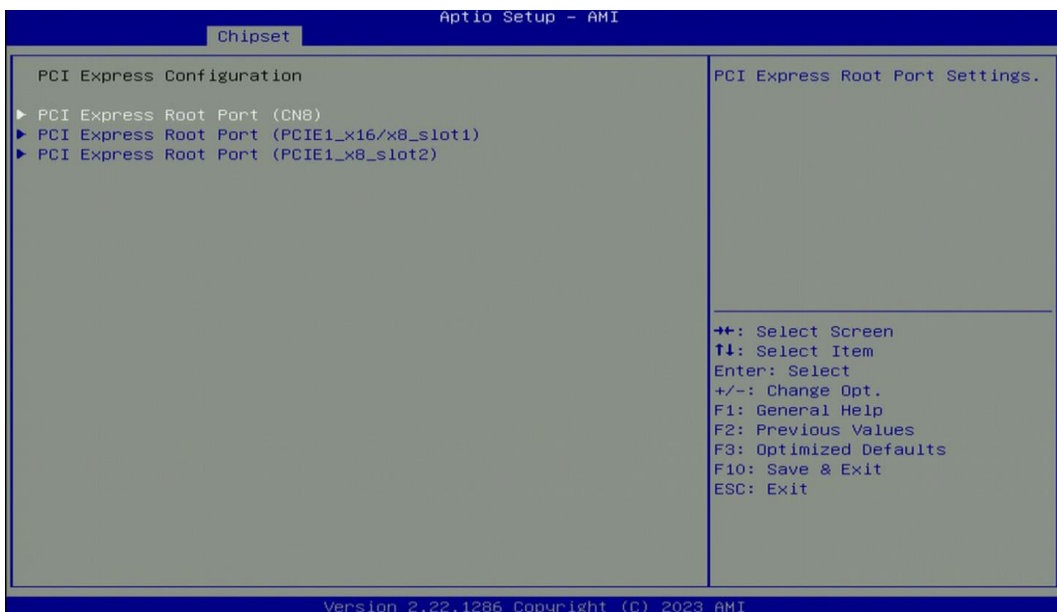

PCI Express Root Port (CN8)

■ PCI Express Root Port [Enabled]

Allows you to enable or disable the PCI Express Port.

■ PCIe Speed [Auto]

Allows you to select PCI Express interface speed.

Configuration options: [Auto] [Gen1] [Gen2] [Gen3].

PCI Express Root Port (PCIe x16/x8_slot1)

PCI Express Root Port [Enabled]

Allows you to enable or disable the PCI Express Port.

PCIe Speed [Auto]

Allows you to select PCI Express interface speed.

Configuration options: [Auto] [Gen1] [Gen2] [Gen3].

PCI Express Root Port (PCIe x8_slot2)

PCI Express Root Port [Enabled]

Allows you to enable or disable the PCI Express Port.

PCIe Speed [Auto]

Allows you to select PCI Express interface speed.

Configuration options: [Auto] [Gen1] [Gen2] [Gen3].

VT-d [Enabled]

This item allows users to enable or disable Intel® Virtualization Technology for Directed I/O (VT-d) function.

Above 4GB MMIO BIOS assignment [Enabled]

This item allows users to enable or disable Above 4GB MMIO BIOS assignment function.

4.4.2 PCH-IO Configuration



■ PCI Express Configuration



PCI Express Root Port (Slot x1)

■ PCI Express Root Port [Enabled]

Allows you to enable or disable the PCI Express Port.

■ PCIe Speed [Auto]

Allows you to select PCI Express interface speed.

Configuration options: [Auto] [Gen1] [Gen2] [Gen3].

- ❑ **PCI Express Root Port (mPCIe CN7)**
 - **PCI Express Root Port [Enabled]**
Allows you to enable or disable the PCI Express Port.
 - **PCIe Speed [Auto]**
Allows you to select PCI Express interface speed.
Configuration options: [Auto] [Gen1] [Gen2] [Gen3].
- ❑ **PCI Express Root Port (mPCIe CN5)**
 - **PCI Express Root Port [Enabled]**
Allows you to enable or disable the PCI Express Port.
 - **PCIe Speed [Auto]**
Allows you to select PCI Express interface speed.
Configuration options: [Auto] [Gen1] [Gen2] [Gen3].
- ❑ **PCI Express Root Port (mPCIe CN6)**
 - **PCI Express Root Port [Enabled]**
Allows you to enable or disable the PCI Express Port.
 - **PCIe Speed [Auto]**
Allows you to select PCI Express interface speed.
Configuration options: [Auto] [Gen1] [Gen2] [Gen3].

■ HD Audio Configuration

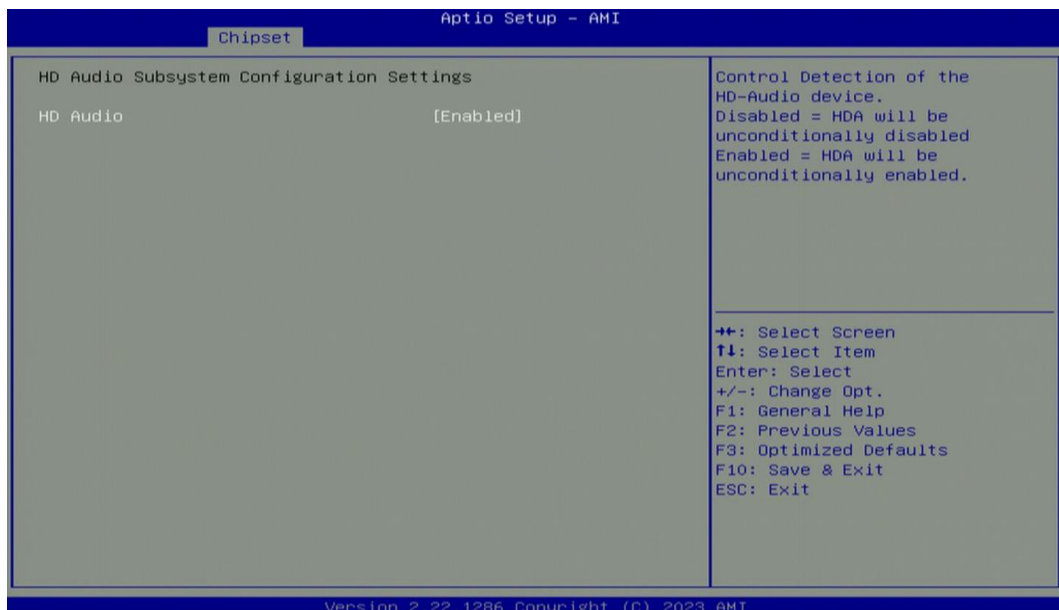

- ❑ **HD Audio [Enabled]**
Allows you to select HD Audio options.
[Enabled]: HD Audio device is unconditionally enabled.
[Disabled]: HD Audio device is unconditionally disabled.

■ LAN i219LM Controller [Enabled]

Enables or disables i219LM LAN Controller.

■ **Wake On LAN (i219) [Enabled]**

Enables or disables integrated LAN i219LM Wake on LAN function.

■ **LAN i210AT Controller [Enabled]**

Enables or disables I210 LAN Controller.

■ **Wake# event (PCIe) [Enabled]**

Enables or disables integrated LAN i210 Wake on LAN function.

■ **CN5 Function Switch [Mini-PCIe]**

Allows users to select [Mini-PCIe] or [mSATA] for CN5 connector.

■ **CN6 Function Switch [Mini-PCIe]**

Allows users to select [Mini-PCIe] or [mSATA] for CN6 connector.

■ **CN7 Function Switch [Mini-PCIe]**

Allows users to select [Mini-PCIe] or [mSATA] or [USB3.0] for CN7 connector.

■ **CN8 Function Switch [PCIe]**

Allows users to select [PCIe] or [SATA] for CN8 connector.

■ **BTB_FH1 Mode Selection [4x1]**

Allows users to select [4x1] or [1x4] for BTB_FH2 Mode.

■ **Audio Amplifier [Enabled]**

Enables or disables Audio Amplifier Function.

■ **Power Failure [Keep last state]**

Allows you to specify which power state system will enter when power is resumed after a power failure (G3 state).

[Always on]: Enters to power on state.

[Always off]: Enters to power off state.

[Keep last state]: Enters to the last power state before a power failure.

4.5 Security Setup

This section allows users to configure BIOS security settings.

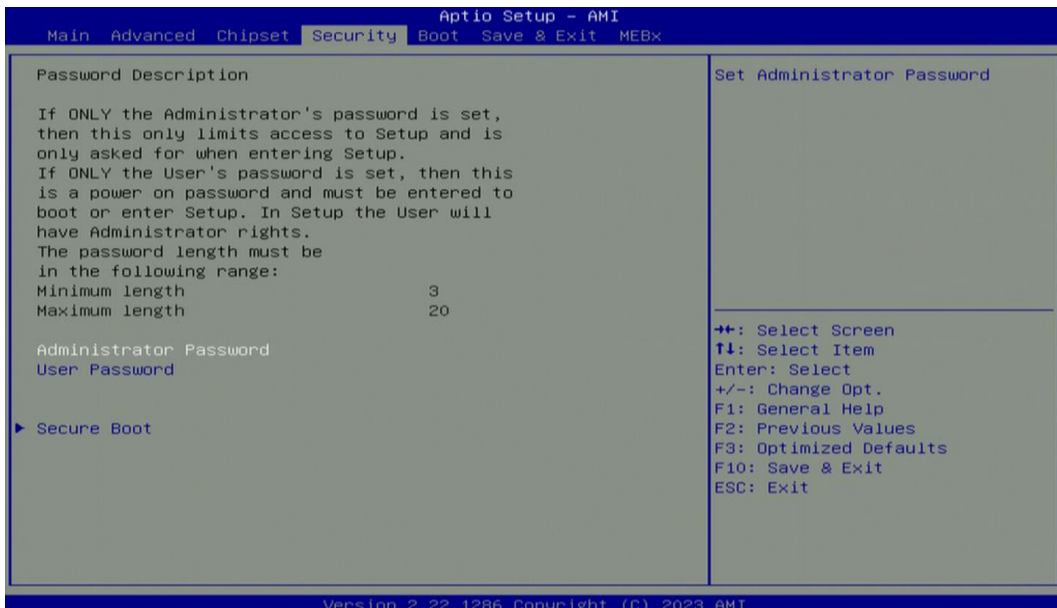

4.5.1 Administrator Password

Administrator Password controls access to the BIOS Setup utility.

4.5.2 User Password

User Password controls access to the system at boot and to the BIOS Setup utility.

4.5.3 Security Boot



- Secure Boot [Disabled]**
Enable or disable Secure Boot function.
- Secure Boot Mode [Standard]**
Allows you to select Secure Boot Mode.
Configuration options: [Standard] [Custom].

4.6 Boot Setup

This section allows you to configure Boot settings.

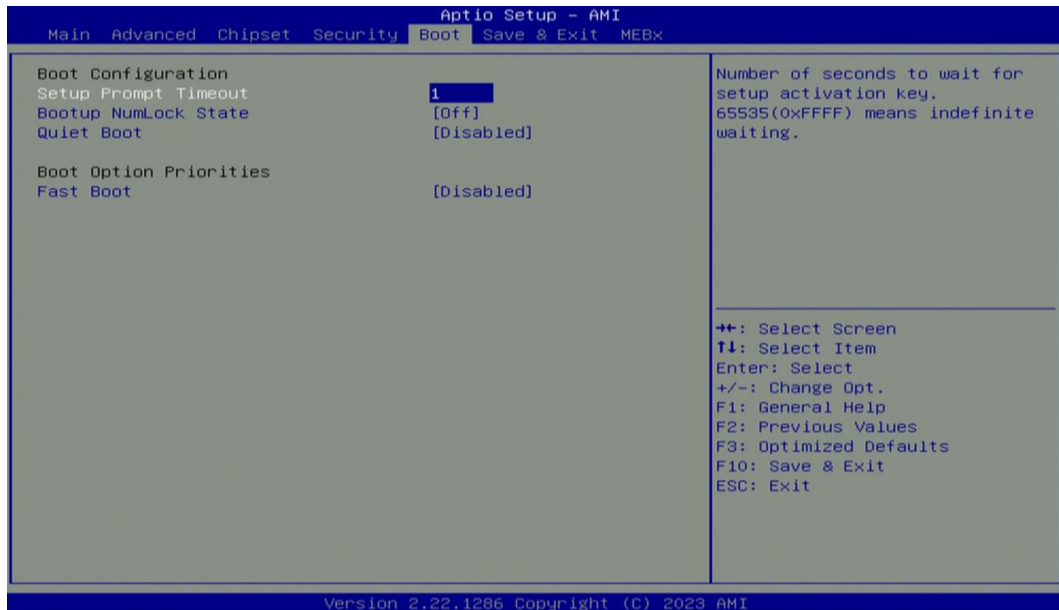

4.6.1 Setup Prompt Timeout [1]

Use this item to set number of seconds (1..65535) to wait for setup activation key.

4.6.2 Bootup NumLock State [Off]

Allows users to select the power-on state for keyboard NumLock.

4.6.3 Quiet Boot [Disabled]

Allows users to enable or disable Quiet Boot function.

4.6.4 Fast Boot [Disabled]

Allows users to enable or disable Fast Boot function.

4.7 Save & Exit

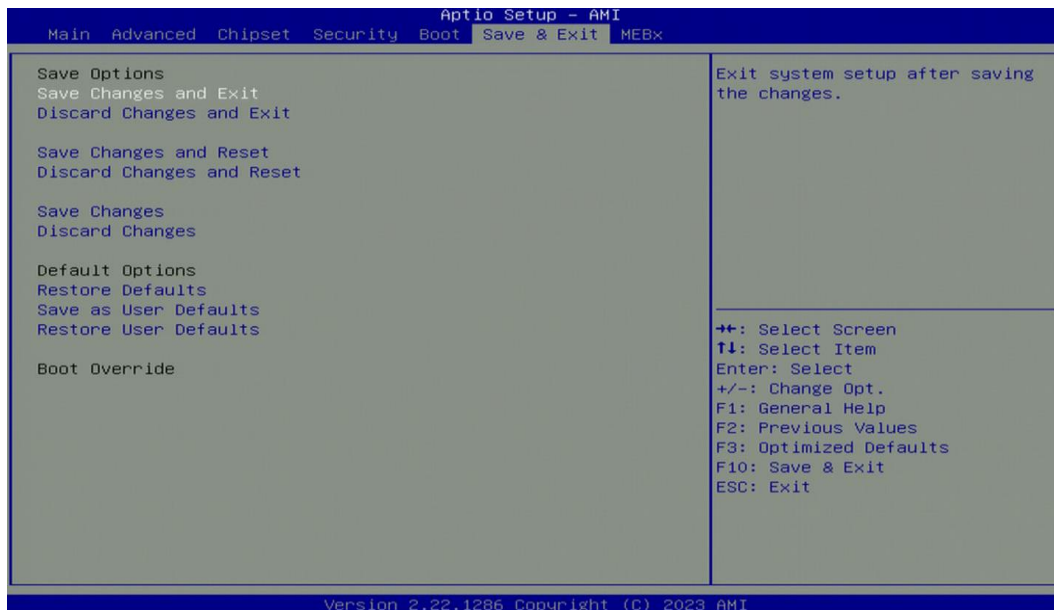

4.7.1 Save Changes and Exit

This item allows users to exit system setup after saving changes.

4.7.2 Discard Changes and Exit

This item allows users to exit system setup without saving changes.

4.7.3 Save Changes and Reset

This item allows users to reset the system after saving changes.

4.7.4 Discard Changes and Reset

This item allows users to reset system setup without saving any changes.

4.7.5 Save Changes

This item allows users to save changes done so far to any of the setup options.

4.7.6 Discard Changes

This item allows users to discard changes done so far to any of the setup options.

4.7.7 Restore Defaults

This item allows users to restore/ load default values for all the options.

4.7.8 Save as User Defaults

This item allows users to save the changes done so far as user defaults.

4.7.9 Restore User Defaults

This item allows users to restore the user defaults to all the options.

4.8 MEBx

This page is for ME function setting. Press the delete key to enter the BIOS menu then user can see the following MEBx page.

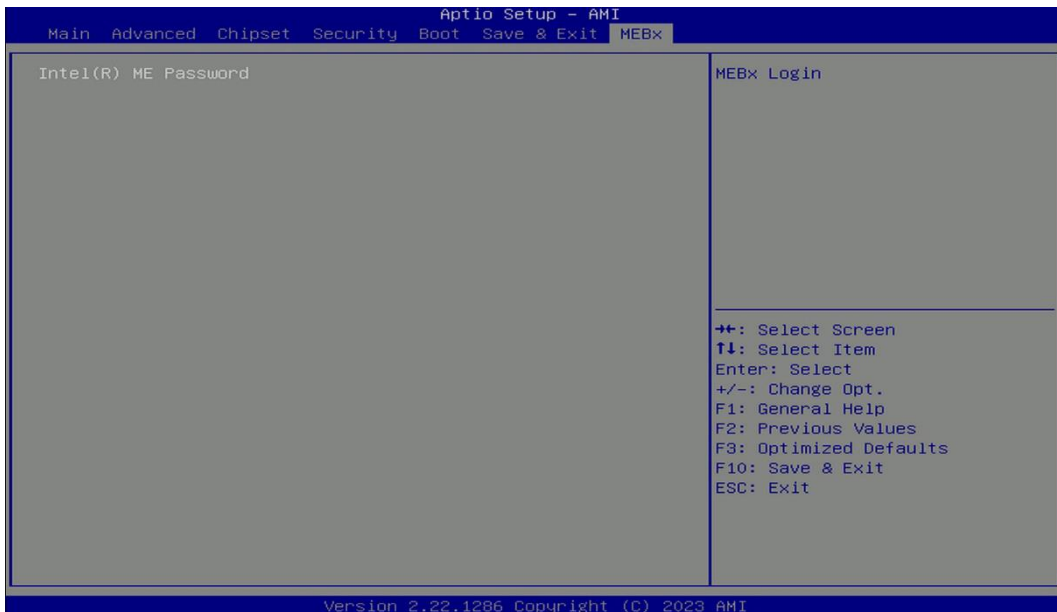

Press enter key to enter the default password "admin" to enter the next step for password creation.

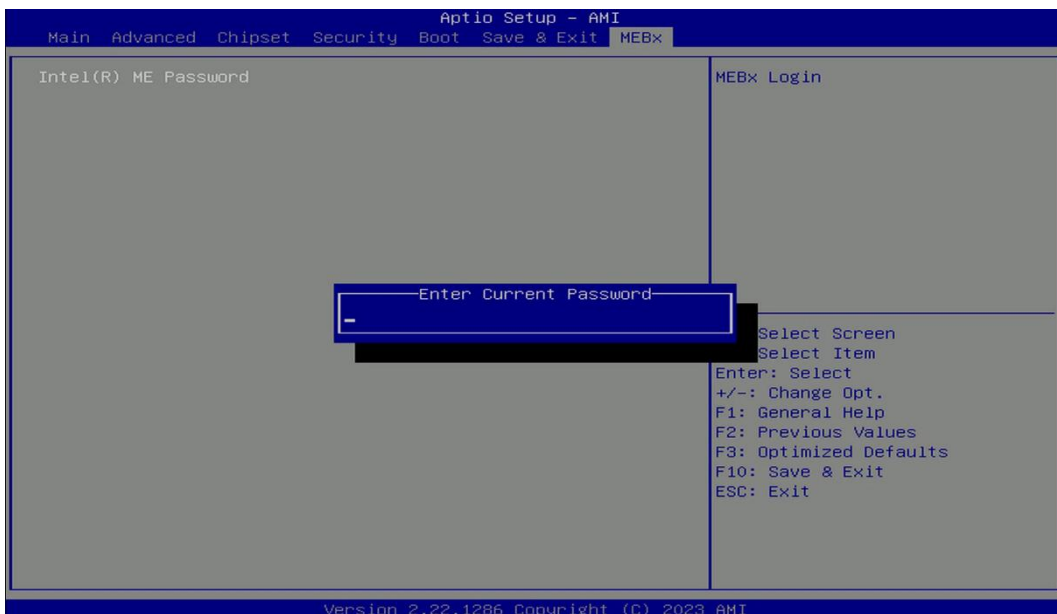

Create a new password using 8 characters including uppercase and lowercase letters, numbers and special symbols.

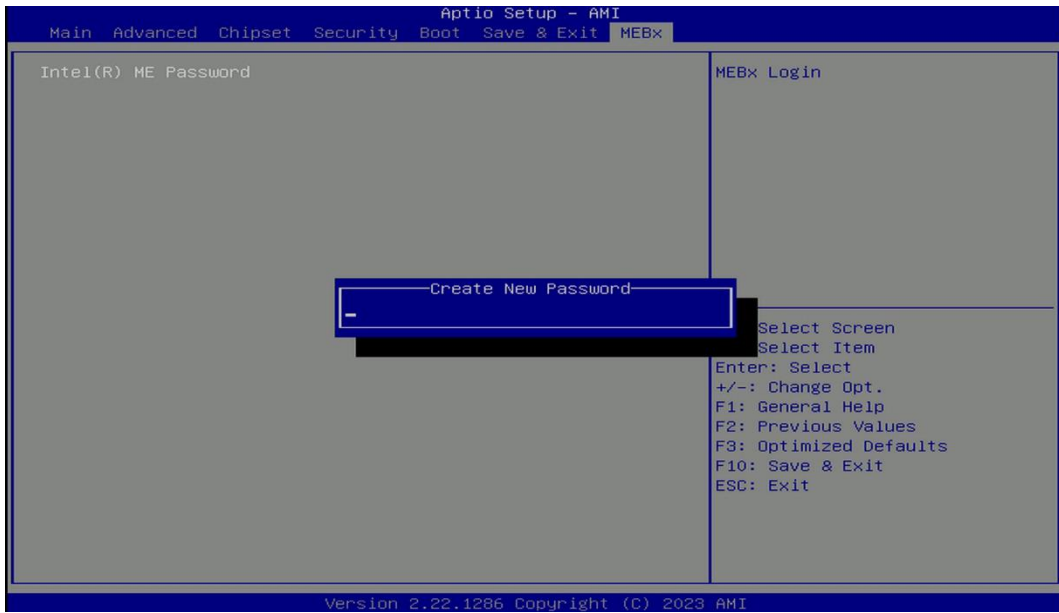

Enter the created password again for confirmation.

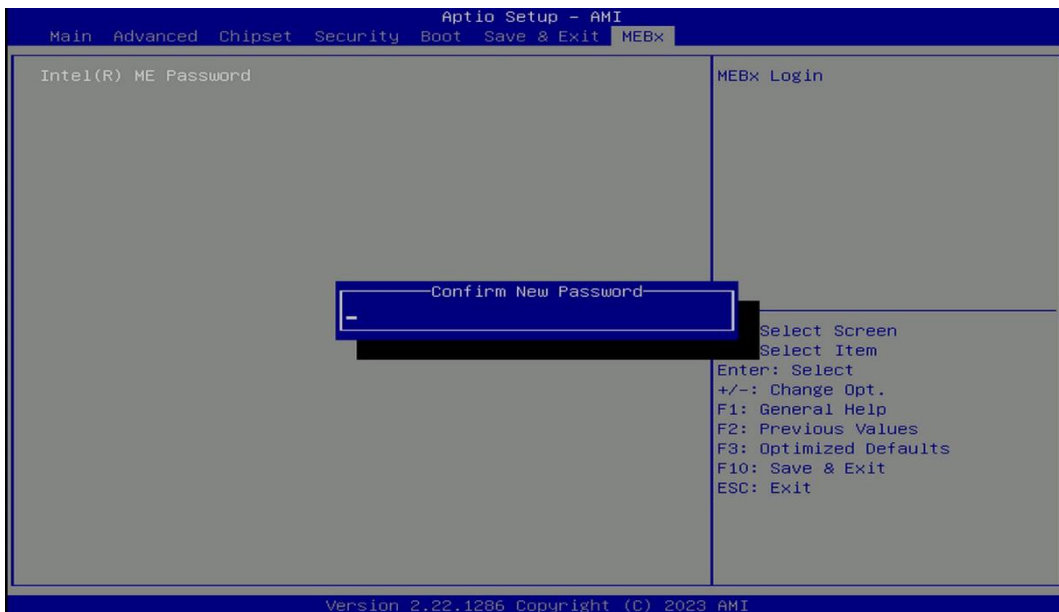

Then you can see the function setting page of MEBx.

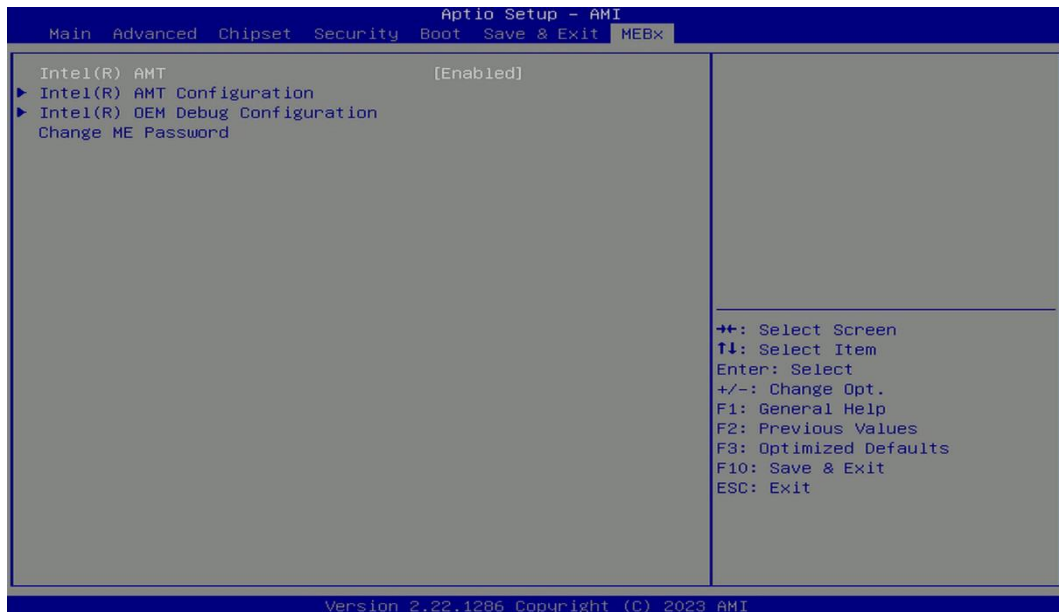



Chapter 5

Product Application

5.1 Where to download drivers?

Please go to the CINCOZE website to download the drivers for DS-1400 series.

5.2 Where to find the technical documents?

Please go to the [CINCOZE website](#) to find the technical documents for DS-1400 series.

Catalog	Document Title
Application Notes	DIO Application Guide
	DIO Technical Guide
	Instant Reboot Application Guide
	WDT Application Guide
	WDT Technical Guide
Configure & Installation	AT ATX Function Manual
	BIOS Administrator User Password Function Manual
	Clear CMOS Function Manual
	COM Function Manual
	CSM Function Manual
	Digital I/O Function Manual
	How to import Secure Boot Key?
	How to restore Windows image with Clonezilla?
	How to set TPM function under Windows?
	How to stop automatic driver update in Windows SOP
	How to Update BIOS and ME under UEFI shell?
	How to Update BIOS under UEFI shell?
	How to Update BIOS under Windows?
	IGN Module User Manual
	Intel AMT with KVM Remote Control
	POE Module User Manual
	PXE Function Manual
	RAID Function Manual
	Remote Switch Function Manual
	Wake On LAN Function Manual
WDT Function Manual	

cincoze

© 2023 Cincoze Co., Ltd. All rights reserved.

The Cincoze logo is a registered trademark of Cincoze Co., Ltd.

All other logos appearing in this catalog are the intellectual property of the respective company, product, or organization associated with the logo.

All product specifications and information are subject to change without notice.